

Garage Essentials

Winter 2019

Issue 37

MILWAUKEE WRENCH KIT

Milwaukee Kit Bundle Includes:

- M18 ½" FUEL 610Nm Mid-Torque Impact Wrench with Friction Ring, 3x 5.0Ah Batteries, Charger and Case
- M12 FUEL 3/8" Stubby Impact Wrench
- M12 2.0Ah Red Lithium-Ion Battery



Part No:
987AB019K

ONLY
£549.00

SEE PAGES 67-68 FOR MORE MILWAUKEE PRODUCTS

SIP ELECTRIC PRESSURE WASHER

T420/180 Cold Water Pressure Washer

- Powerful 2100w induction motor with overload cut out – for smoother operation and extended motor life
- 2610psi (180 bar) max. pressure
- 420 ltr/hr water flow rate
- Auto-stop function – the machine stops automatically after the lance stops spraying
- All-metal pump
- Heavy duty metal lance
- 5 metre hose length
- Built-in detergent tank
- Extra-large wheels – for easy movement
- 1 year warranty

Part No:
08910

ONLY
£129.95

UNBEATABLE VALUE!!



MORE SIP PRESSURE WASHERS ON PAGE 23

SUPER QUIET PORTABLE PARAFFIN DIESEL SPACE HEATERS

HEATERS EXCLUSIVELY AVAILABLE TO THE PARTS ALLIANCE

DON'T BE COLD THIS WINTER!!

DIESEL SPACE HEATERS FROM £239.95

75,000 - 125,000 BTU OPTIONS AVAILABLE



SEE PAGES 4-7 FOR MORE Z.M. HEATER PRODUCTS

SIP TEMPEST PH540/150 HOT WATER PRESSURE WASHER

CLEAN UP WITH THE SIP HOT PRESSURE WASHER AT ONLY

£995

 **MADE IN ITALY**

Part No:
08954



TWO YEAR WARRANTY

MORE DETAILS ON PAGE 23

Enquiries: 0121 749 8801

THE Parts Alliance
Local Service • National Strength

GSF CAR PARTS BRANCHES



ANDOVER	01264 839999
BANBURY	01295 221133
BARNSTAPLE	01271 402 555
BASINGSTOKE	01256 710200
BEDFORD	01234 573375
BELFAST	028 9066 3866
● BIRMINGHAM	0121 749 8815
BRADFORD	01274 652020
BRISTOL (NORTH)	0117 322 4078
BRISTOL (CENTRAL)	0117 9557 654
BRISTOL (SOUTH)	0117 338 0380
CANTERBURY	01227 811088
CARDIFF	029 2034 7900
CHADWELL HEATH	020 8598 8800
CHELMSFORD	01245 460460
CHELTHENHAM	01242 225620
COLCHESTER	01206 203006
COVENTRY	024 7666 9988
DAVENTRY	01327 871009
DERBY	01332 346680
DONCASTER	01302 762762
DUBLIN (NORTH)	01 862 2884
DUBLIN (SOUTH)	01 460 6062
EXETER	01392 610666
FARNHAM	01252 333891
FINCHLEY	020 8104 0404
GLASGOW	0141 433 4080
GLOUCESTER	01452 212212
HARLOW	01279 342200
HARROW	020 8960 8182
HEATHROW	020 8917 3800
HUDDERSFIELD	01484 434333
IPSWICH	01473 748166
KETTERING	01536 526899
KINGSTON	020 8547 3101
LEAMINGTON SPA	01926 451980
LEEDS (EAST)	0113 201 9030
LEEDS (WEST)	0113 244 3637
LEICESTER	0116 234 0200
LETCHEWORTH	01462 708800
LINCOLN	01522 575333
LIVERPOOL	0151 525 1764
LUTON	01582 506940
MIDDLESBROUGH	01642 226400
MILTON KEYNES	01908 872278
NORTHAMPTON	01604 609080
NORWICH	01603 780900
NOTTINGHAM	01159 503723
OXFORD	01865 972 972
PETERBOROUGH	01733 293444
PLYMOUTH	01752 330011
POOLE	01202 741060
PORTSMOUTH	02392 728970
READING	01189 873030
ROCHDALE	01706 202202
ROMFORD	OPENING SOON
SHEFFIELD	01142 617888
SITTINGBOURNE	01795 402402
SMETHWICK	0121 565 6340
SOUTHAMPTON (WEST)	023 8086 3900
SOUTHAMPTON (NORTH)	0238 124 2636
SOUTHEND-ON-SEA	COMING SOON
STAPLES CORNER	020 8208 6444
SWANSEA	01792 704980
SWINDON	01793 836940
THURROCK	01708 890740
TORQUAY	01803 242400
TOTTENHAM	020 8104 8020
TRAFFORD	0161 876 0466
WATFORD	01923 229255
WOLVERHAMPTON	01902 350940
WOODFORD GREEN	0203 2802611

DINGBRO BRANCHES



ABERDEEN	01224 682000
ARBROATH	01241 876414
AYR	01292 266400
BATHGATE	01506 633335
BELLSHILL	01698 744328
CARLISLE	01228 584888
DUMFRIES	01387 270250
DUNDEE	01382 643000
DUNFERMLINE	01383 748210
EAST KILBRIDE	01355 236500
EDINBURGH (GYLE)	0131 453 8360
EDINBURGH (LEITH)	0131 657 6464
ELGIN	01343 552888
FALKIRK	01324 677100
FRASERBURGH	01346 512345
GALASHIELS	01896 664800
GLASGOW	0141 554 9998
GREENOCK	01475 552556
INVERNESS	01463 236686
KIRKCALDY	01592 654212
MONTROSE	01674 675311
PAISLEY	0141 887 2033
PERTH	01738 443388
PETERHEAD	01779 476551
SIGHTHILL	0131 316 4955
STIRLING	01786 463300
STRANRAER	01776 705777

CES BRANCHES



ANGLESEY	01248 422000
BURTON	01283 500 006
CAERNARFON	01286 673504
CANNOCK	0844 736 0101
CHESTER	01244 377118
CREWE	01270 214216
DERBY	01332 202802
HALESOWEN	0844 7360560
ISLE OF MAN	01624 620000
LIVERPOOL	0151 2076667
LLANDUDNO	01492 592144
MACCLESFIELD	01625 427733
MANCHESTER (SOUTH)	0844 7360566
NORTHWICH	01606 353200
PORTHMADOG	01766 515414
RHYL	01745 355505
SHREWSBURY	01743 440088
SOUTHPORT	01704536446
STOKE	01782 844395
TELFORD	01952 581666
WIDNES	0844 736 1122
WREXHAM	01978 365392

GMF BRANCHES



BRIDGEND	01656 649493
CAMARTHEN	01267 237977
CARDIFF (NORTH)	02920 628686
CARDIFF (EAST)	02920 489150
CHELTHENHAM	01242 252100
COLEFORD	01594 832092
GLOUCESTER	01452 528800
HAVERFORDWEST	01437 760428
LLANELLI	01554 775772
MERTHYR	01443 699002
NEATH	01639 641118
NEWPORT	01633 280001
ROSS ON WYE	01989 769921
SWANSEA	01792 790080

CAR PARTS & ACCESSORIES BRANCHES



BRIGHTON	01273 701777
BURGESS HILL	01444 258831
CHICHESTER	01243 771331
EAST GRINSTEAD	01342 321456
EASTBOURNE	01323 410817
HASLEMERE	01428 654444
HENFIELD	01273 495880
HORSHAM	01403 257325
LEWES	01273 487828
LITTLEHAMPTON	01903 719990
PETERSFIELD	01730 260000
WORTHING	01903 823123

SC MOTOR FACTORS BRANCHES



ASHFORD	01233 502379
CHATHAM	01634 847793
CROYDON	0208 970 7734
DEAL	01304 362161
DOVER	01304 210712
FOREST HILL	020 8314 4750
HASTINGS	01424 435588
MAIDSTONE	01622 766410
SIDCUP	020 8302 7624
STROOD	01634 712212
THANET	01843 298676
TUNBRIDGE WELLS	01892 518028
WELLING	020 8317 7774

ALLPARTS BRANCHES



AYLESBURY	01296 737873
ENFIELD	020 8443 8090
HAYES	020 8573 0033
HEMEL HEMPSTEAD	01442 868040
HIGH WYCOMBE	01494 441234
OXFORD	01235 550555
SLOUGH	01753 215080
WATFORD	01923 239039

PARTS ALLIANCE BRANCHES



BARNSTAPLE	01271 375801
CHARD	01460 65053
EXETER	01392 258279
FROME	01373 465961
INDIAN QUEENS	01637 849377
MIDSOMER NORTON	01761 298855
PENRYN	01326 372651
PLYMOUTH	01752 668931
TAUNTON	01823 259691
TIVERTON	01884 256767
WESTON SUPER MARE	01934 886544
WEYMOUTH	01305 360875

BBC SUPERFACTORS BRANCHES



ACCINGTON	01254 239911
BLACKBURN	01254 53463
BLACKPOOL	01253 843373
BURNLEY	01282 450005
CHORLEY	01257 233833
CLITHEROE	01200 425525
PRESTON	01772 281711
RAWTENSTALL	01706 260638

SAS AUTOPARTS BRANCHES



BRADFORD	01274 733 888
CASTLEFORD	01977 558 833
DURHAM	0191 336 1990
GOOLE	01405 658031
HARROGATE	01423 889 021
LEEDS	0113 292 4999
MIDDLESBROUGH	01642 386477
NEWCASTLE	0191 204 9555
NORTHALLERTON	01609 779 551
OTLEY	01943 467 514
SKIPTON	01756 799 500
SOUTHEND	01702 27 7969
SUNDERLAND	01916 444789
YORK	01904 690 761

BMF BRANCHES



BROMSGROVE	01527 575444
KIDDERMINSTER	01562 864333
MALVERN	01684 882699
REDDITCH	01527 520445
WORCESTER	01905 29990

BMS SUPERFACTORS BRANCHES



BURY	0161 7614012
DUKINFIELD	0161 339 6694
OLDHAM	0161 626 3199
ROCHDALE	01706 660660

WATERLOO BRANCHES



BEVERLEY	01482 871771
BRIDLINGTON	01262 400900
HULL	01482 328308

Capital Equipment

Air Compressors	
Champion	Page 60, 61, 62, 63
SIP	Page 21
Gas/Smoke Analysers	
Bosch	Page 49
Bradbury	Page 25
Crypton	Page 43
Hofmann	Page 36
MOT Equipment	
Bosch	Page 49
Bradbury	Page 25
Crypton	Page 43
Hofmann	Page 36
Liftmaster	Page 34
Tecalemit	Page 28
Heaters	
Z.M. Heaters	Page 1, 4, 5, 6, 7
SIP	Page 20

Capital Equipment (continued)

Spray Booths	
Rowley	Page 40
Vehicle Lifts	
Bradbury	Page 27
Crypton	Page 41
Dunlop	Page 24, 26
EAE	Page 32, 33
Hofmann	Page 37
Liftmaster	Page 34, 35
Ravaglioli	Page 66
Tecalemit	Page 29

Vehicle Air Conditioning

AC Machines	
Bosch	Page 47
Cooling Edge	Page 56, 57

Diagnostics

Training	
Our Virtual Academy	Page 9
Vehicle Diagnostics	
Autel	Page 52, 53
Bendix	Page 54
Bosch	Page 46, 47
Delphi	Page 50, 51
Laser Tools	Page 14
Texa	Page 44, 45
VCDS	Page 55
VDO	Page 42

Wheel & Tyre

Tyre Changers, Balancers & Monitoring	
Bosch	Page 49
EAE	Page 33
Hofmann	Page 38, 39
Liftmaster	Page 35
Tecalemit	Page 30
VDO	Page 42

Wheel & Tyre (continued)

Wheel Alignment	
Hofmann	Page 37, 39
Tecalemit	Page 31
Texa	Page 45

Training

Our Virtual Academy	Page 9
---------------------	--------

Workshop Equipment

Coil Spring Compressors	
Angry Jester	Page 19
Battery Chargers / Testers	
Bosch	Page 48
SIP	Page 20
Booster Pack	
Laser Tools	Page 14
SIP	Page 20
Hand/Workshop Tools	
Angry Jester	Page 16, 17, 18, 19
Laser Tools	Page 12, 13, 14, 15
Milwaukee	Page 1, 67, 68
Sealey Tools	Page 10, 11
Pressure Washers & Scrubbers	
Kärcher	Page 58, 59
SIP	Page 22, 23
Transmission Jacks, Trolley Jacks, Jacking Beams	
Bendpak	Page 35
Liftmaster	Page 35
Winntec	Page 64, 65
Winntec	Page 21
Welding	
SIP	Page 21
Workshop Lighting	
Angry Jester	Page 16, 17, 18
Laser Tools	Page 14
Unilite	Page 8
Vacuum Cleaners	
Kärcher	Page 58, 59
SIP	Page 22

Find Us On



Z.M. AUTOMATIC MULTI FUEL HEATERS

ZM Heaters have added a range of 90% efficient, auto-ignition warm air blowing cabinet heaters for the 2018/2019 season

PRICE MATCH GUARANTEE

- **Designed for multiple fuels** - with resistant stainless steel combustion chambers and heat exchangers, with easy access to clean
- **Quality components** - inc Soler & Palau centrifugal fans and Honeywell double-limit fan thermostats
- **Rugged construction** - simple design using strong materials, for longer operating life
- **Supplied with European oil burner** - Citerm JUNIOR or G-series burners included
- **Connecting hoses included** - supplied with either floating pick-up or in-line filter
- **Safety controls** - all burners have overheat, overflow and flame-out protection included
- **Push button control** - turn on / off or add a room thermostat / timer to control remotely
- **Lower maintenance** - higher burning temperatures reduce cleaning frequency
- **12 months warranty**

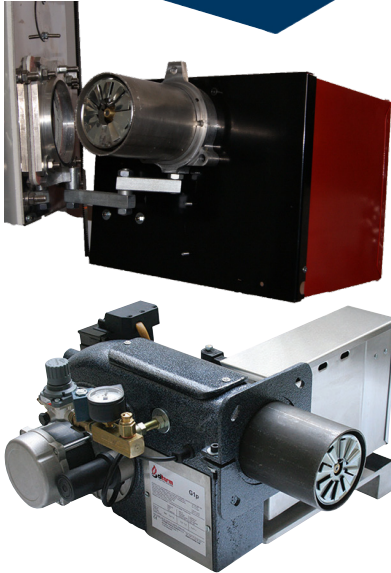

170kW Automatic Heater also available - POA!

Features	Units	Z-45	Z-80	Z-120
Rating (gross / nett)	Btu/hr	143,000	307,000	460,000
Power supply	V	220-240 (single phase)		400 (3 phs)
Power intake	kW	.25	.37	1.1
Airflow	m³ per hour	2,900 m³ per hour	4,500 m³ per hour	7,900 m³ per hour
Width x Depth x Height	cm	46 x 75 x 160	61 x 81 x 195	61 x 101 x 195
Flue ø	mm	115 (5")	154 (6")	154 (6")
Price inc delivery	£	3,329	3,895	4,445

HOW MUCH HEAT DO I NEED TO GENERATE?

Here is your step by step guide for working out how much heat you need.

- Area to be heated, length.....feet, width.....feet, average height.....feet
- Multiply, length x width x average height = volume.....cubic feet
- Select the description which best suits the area to be heated from the table below and fill in the appropriate Btu/cu.ft figure here.....
- Multiply the volume from B.....Cubic feet by the figure from C.....Btu/cu.ft = Total heat required.....Btu/hour

The amount of Btu/cu.ft required is dependent on the insulation of the building and the average ambient temperature prevailing in the area where the building is situated. A building with no insulation in the area that experiences extremely adverse weather conditions may require up to 9 Btu per cu.ft

For general calculation we recommend 5 Btu per cu.ft. * 1 cubic metre = 35 cubic feet

A comfortable working temperature is not only essential for people to work safely and productively it is a legal requirement. The amount of heat required to give comfortable working conditions depends on several factors, the most important are:

- The standard of insulation in your building
- How much warm air escapes through frequently opened doors
- The outside temperature
- 15 C / 59° F is a comfortable temperature for people who are moving about and so generating some body heat
- Calculations are based on a Delta T of 20° C, i.e. an ambient temperature of -5° C and a required temperature of +15° C

Which description best fits the building or area that you want to heat?

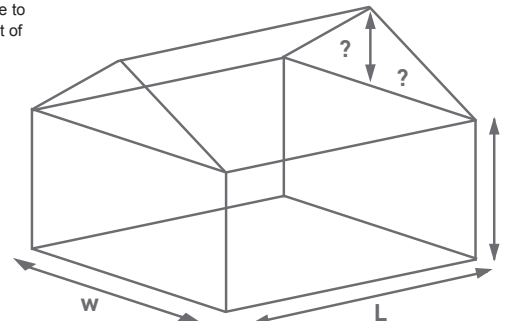

A	No insulation (e.g. corrugated sheet), doors frequently opened	9 Btu/cu.ft
B	Poor insulation (e.g. single skin brick/block), single glazed windows, opened fairly often	6,8 Btu/cu.ft
C	Average insulation (e.g. double skin brick/block), single glazed windows, roof insulated	5 Btu/cu.ft
D	Good insulation (e.g. blocks/cladding/insulation between), few or double-glazed windows	2,7 Btu/cu.ft

ZM-150 MULTI FUEL HEATER

This heater boasts class-leading features including 75 litre fuel tank, massive 52 kW maximum heat output, high capacity blower fan and unique built-in heat exchanger.

Reliable, efficient, versatile heating for smaller sized workshops

- 'Plug and play' 220-240V power supply
- With built-in fuel storage tanks
- Simple control panels with unique 5x LED operating function display
- Fully variable output control
- Blower fans for the winning combination of radiant heat and air circulation
- **Multi-fuel** – waste engine oil, hydraulic oils, red diesel, diesel or bio-fuels can all deliver clean, efficient workshop heat
- **Up to 90% efficient** – with the 'Heater Booster'
- **Fast & free UK delivery** – arrives in just 2 to 3 working days
- **Draft stabilisers included** – simply add / connect to 150mm flue
- **Safety controls** – overheat and overflow protection switches
- **Cleaning pan included** - to quickly scrape and clean away any soot

Part No: 987AA722K
WITH FLUE KIT

£1,895.00

Weekly from: £10.06†

Part No: 987AA7220
WITHOUT FLUE KIT

£1,749.00

Weekly from: £9.28†

2 YEAR WARRANTY* & LOWER PRICES



EUROPEAN MADE

177,000 BTU

177,000 Btu of heat 52 kW, clean and affordable!

HEATER BOOSTERS

Boost the efficiency of your Heater by 40%. Just add a Heater Booster

The heater booster is an in-line multipass stainless steel flue gas heat exchanger which can raise efficiency on HP heaters to over 90%. This means **over 40% more heat** is realised from your fuel that would otherwise be lost up the flue. A 220-240v supply is required for the fan. The booster simply slots onto any 150mm flue sector before the flue. The heat outlet can be ducted if required (see as illustrated).

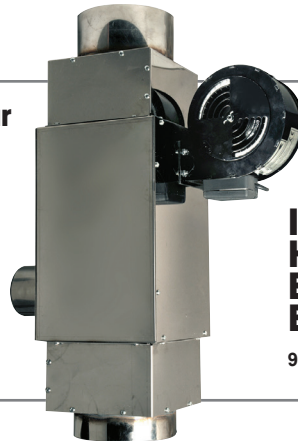

£299.95

IMPROVES HEATER EFFICIENCY BY 40%

987AA7240

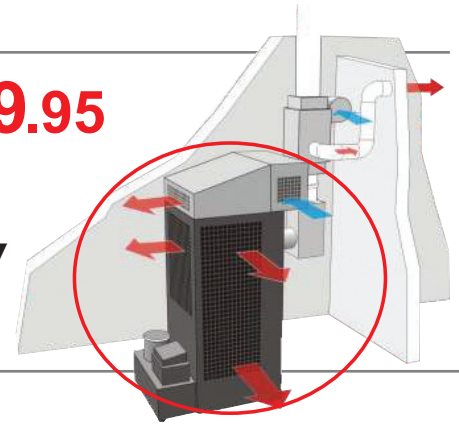

Specifications compared:

	ZM-150
NEW LOWER PRICES	NOW SAVE 5%
Output range kW (Btu)	30 – 52 (102,000 – 177,000)
Weight	115 kg
Dimensions H x W x D - cm	147x 70 x 100
Max fuel usage	5.2 litres per hour
Air flow	5,400 m ³ per hour
Tank capacity	75 litre
Warranty as standard	2 years

UK-manufactured stainless steel flue kits from just £199.95 + VAT for a basic 5m kit. Need to exit a rear wall and not sure what you need? Want to add a roof seal? - No problem! All our flue kits are sourced to order from manufacturer - delivering exactly what you need.

Heater Booster inline stainless-steel heat exchanger will recover heat that would be lost back into the workshop only £299.95 + VAT when ordered with a heater. The booster adds 270 m³ per hour air flow from 80mm twin outlets (dimensions: H 61cm x W 37cm x D 42cm and 8.7 kg weight).

**CALL FOR MORE INFO
HURRY WHILE STOCKS LAST!**

*2 Year Warranty Terms - covers sudden or unforeseen failures on a parts-only basis, specifically excluding burner dishes and thermostats, which are consumable items each carrying 6 months goodwill warranty from date of heater purchase. For full details: <http://www.zmosystems.co.uk/trading-terms-conditions>.

Contact your local branch for details or call **0121 749 8801**

SUPER QUIET PORTABLE PARAFFIN DIESEL SPACE HEATERS



70,000 BTU

Part No: ZMQ-K70
987AA7270
£239.95



125,000 BTU

Part No: ZMQ-K125
987AA7280
£295.95

**26% more
Heat than
other units**

HEATERS EXCLUSIVELY AVAILABLE TO THE PARTS ALLIANCE

Z.M. Heaters offer high specification heaters, sourced direct from world-renowned factories, to the UK market at exceptionally low prices. The Z.M. Heater range is distributed exclusively into the automotive aftermarket by The Parts Alliance.

Z.M. Heaters keep things simple with UK manuals written in plain English and fast support, with spares in stock and experienced engineers.

Please visit: www.zmosystems.co.uk

CAL

Choice of 5 models:

	987AA7270	987AA7280
Output kW (Btu)	20kW (70,000)	36kW (125,000)
Weight	12 kg	24 kg
Max fuel usage	1.9 litres per hour	3.6 litres per hour
Air flow	400 m ³ per hour	900 m ³ per hour
Tank capacity	19 litre	38 litre
Move with	Carry handle	Trolley & wheels

SUPER QUIET INDIRECT DIESEL SPACE HEATER

Portable Heavy Duty Paraffin Diesel Space Heaters

Powerful, durable heaters offering significantly better heat. Sourced from a world-leading factory, this range offers better quality and reliability than many other heaters that will cost far more.

**DON'T BE
COLD THIS
WINTER!!**



Part No: ZMID-K135
987AA7260
£499.00



CLICK FOR MORE INFO

987AA7290	987AA7250	987AA7260
51kW (175,000)	17.6kW (60,000)	42.5kW (145,000)
27 kg	17 kg	42kg
4.2 litres per hour	1.2 litres per hour	4.2 litres per hour
1,100 m ³ per hour	100 m ³ per hour	1,500 m ³ per hour
50 litre	13 litre	49 litre
Trolley & wheels	Carry handle	Trolley & wheels

- **Quick, cost-effective** heat, no installation, near-100% efficiency
- Run on **diesel, red diesel, paraffin** or heating oils
- Supplied with **UK 220-240V mains plug**
- Built-in variable **thermostat control** for auto on / off cycling
- Digital **room temperature read-out with built-in diagnostics** (not on ZMQ-K70 only)
- Full **safety controls** include flame-out and overheat shut-down
- **UK manual** including service procedures, trouble-shooting, parts diagrams etc
- **Fast delivery** – typically delivered next working day
- **12 months warranty** - spares & service parts in UK stock
- Made in South Korea

USB RECHARGEABLE INSPECTION LIGHTS



Unilite 500 Lumen Rechargeable LED Inspection Light

- 9x white Samsung SMD LEDs - 500 Lumen
- DC-USB charging cable (included)
- Additional 200 Lumen torch in head
- Magnetic pocket clip for hands free use

BATTERY: 3.7v 2500 mAh lithium-ion rechargeable battery included
WEIGHT: 200g (not including cable)
DIMENSION: 180 x 35 x 32mm

ONLY

£29.99

Part No: 987AB0010

3-7 HOURS RUNTIME	IP54 DUST & WATER RESISTANT
52 METRE BEAM RANGE	500 LUMEN OUTPUT



CALL FOR MORE INFO

USB Rechargeable LED Inspection Light

- 27x White Samsung SMD LEDs
- Additional 250 lumen torch in the head
- Ultra strength aluminium and polycarbonate housing
- Integral hanging hook and strong magnet for handsfree use
- Multi positional hook / foldable kick stand
- DC-USB charging cable included for portable non-static charging
- Red-to-Green charging indicator light
- **Operating Temperature:** -5 °C to +40 °C
- **Protection Class:** IP54 (do not submerge)
- Impact Resistant to 1m

BATTERY: 3.7v 5000 mAh lithium-ion rechargeable battery

WEIGHT: 338g (with battery)

DIMENSION: 205 x 60 x 42 mm

3-32 HOURS RUNTIME	IP54 DUST & WATER RESISTANT
60 METRE BEAM RANGE	1000 LUMEN OUTPUT

ONLY

£45.00

Part No: 987AA8100

1000 LUMENS

3M THINSULATE USB RECHARGEABLE BEANIE HEADLIGHT



GENUINE THINSULATE USB Rechargeable Beanie Headlight

NOT TO BE CONFUSED WITH ORDINARY HATS



2½-6½ HOURS RUNTIME	IPX5 WATER RESISTANCE
13 METRE BEAM RANGE	150 LUMEN OUTPUT

THE ORIGINAL AND PATENTED BEANIE HAT!

Part No: 987AB0030

- 4x high powered cool white 6500k Samsung SMD LEDs - 150 lumen
- Gives you between 2.5 and 6.5 hours of light off one charge
- Removable light can be charged directly through a USB port
- Can be fully charged in 4 hours
- Comfortable GENUINE THINSULATE lined Beanie Hat, one size fits all

Normally ~~£29.99~~
ONLY £15.95

USB RECHARGEABLE PENLIGHT



BATTERY: 3.7v 350 mAh lithium-ion rechargeable battery included
WEIGHT: 30g
DIMENSION: 127 x 18mm x 20mm

Part No: 987AB0020



ONLY

£23.95

2 HOURS RUNTIME	IPX4 WATER RESISTANT
3 METRE BEAM RANGE	125 LUMEN OUTPUT

DUAL POWER SMD HELMET HEADLIGHT

BATTERY: 1 x 3.7v 1800mAh Li-Polymer Battery Pack (inc) or 3x AAA Alkaline (not inc.)
WEIGHT: 86g (with lithium battery pack) or 94g (with 3x AAA batteries)
DIMENSION: Headlight: 50 x 65 x 45mm

Part No: 987AB0040

NEW



- 350 Lumen white Samsung SMD LEDs
- Dual power options
- 3M VHB adhesive helmet mount (inc.)
- Easy push button micro switch
- Anti-dazzle retractable light shield
- 1800mAh Li-polymer direct micro-USB rechargeable battery pack (included)

- 3x AAA Battery case (included)
- Fully adjustable non-slip silicone headband
- Impact resistant to 1m

ONLY

£54.95

3-59 HOURS RUNTIME	IPX6 WATER RESISTANT
27 METRE BEAM RANGE	350 LUMEN OUTPUT

MAINS INSPECTION LED LEAD LAMP

BATTERY: Mains powered
WEIGHT: 2kg
DIMENSION: 70 x 450mm

- 750 Lumen 10W white COB LED
- Industrial strength polycarbonate
- Mains cable operated
- 230v ultra tough 5m cable
- Hanging hook for easy placement
- IK07 shockproof
- Rubberised handle for extra grip
- Smooth even beam spread
- Impact resistant to 1m
- Chemical and corrosion resistant



ONLY

CALL FOR MORE INFO

Part No: 987AA6490

£34.95



EXCLUSIVE TO THE PARTS ALLIANCE - TRAINING WHEN YOU NEED IT AT YOUR FINGER TIPS



Manufacturer Level Technical Training designed specifically for the Independent aftermarket.

Interactive video content, designed to save you money & improve your workshop productivity.

A LIBRARY OF TRAINING MODULES WITH YOUR OWN VIRTUAL TRAINER AT YOUR FINGER TIPS

www.OurVirtualAcademy.com

**Single User Plan,
2-5 User Plan
(or) 6-10 User
Plan Available**

What is 'Our Virtual Academy'?

- Video based technical training courses
- Online - unlimited access
- Ideally suited to 'a little and often' training approach
- Improved knowledge retention over face to face training
- More than 100 chapters with content added regularly
- Topics include Hybrid, Air Conditioning, Engine Management, Essential Electrical Skills, Chassis Systems, Vehicle Body Electrics and many more

Management Features:

- Built in learning management system monitors training progress*
- Integrated certification system
- Up to 8 IMI CPD points can be logged per hour of training

*Multi user plans



CALL FOR MORE INFO

ANNUAL PLANS

	PART NUMBER	PRICE +VAT
Single User	MISOVASUP	£319.99
Small Business (2-5 users)	MISOVASBP	£429.99
Larger Workshop (6-10 users)	MISOVALWP	£749.99

ONE BATTERY FITS ALL

NEW RANGE



20V LITHIUM RECHARGEABLE

A 20V HAMMER DRILL/DRIVER - BODY ONLY

- 2-13mm Keyless chuck.
- Three drill functions and 18 torque settings provide the control required to complete various tasks.
- Built-in LED work light.
- Forward, reverse and trigger lock.
- Supplied with belt hook for safer storage whilst not in use.
- **Model No. CP20VDD**
- List Price £69.95

B 20V OSCILLATING MULTI-TOOL BODY ONLY

- Built-in LED work light.
- Quick blade change system.
- Includes sanding paper, backing pad, plunge saw blade, segment saw blade and scraper.
- Six speed settings.
- **Model No. CP20VMT**
- List Price £77.95

C 20V 1/4"HEX DRIVE IMPACT DRIVER 180NM - BODY ONLY

- 1/4"Hex quick release chuck.
- Variable speed control trigger.
- Forward, reverse and trigger lock.
- Built-in LED work light.
- Supplied with belt hook for safer storage whilst not in use.
- **Model No. CP20VID**
- List Price £69.95

D 20V 1/2"SQ DRIVE IMPACT WRENCH 230NM - BODY ONLY

- Variable speed trigger switch for easy control.
- Built-in LED work light.
- Forward, reverse and trigger lock.
- Fitted with electronic brake.
- Supplied with belt hook for safer storage whilst not in use.
- **Model No. CP20VIW**
- List Price £69.95

E 20V RECIPROCATING SAW - BODY ONLY

- Durable composite housing with soft grip for added comfort.
- Built-in quick blade change system.
- Variable speed control trigger switch.
- Supplied with wood and metal cutting blades.
- Two stage operation switch for added safety.
- **Model No. CP20VRS**
- List Price £79.95

F Ø125MM 20V RANDOM ORBITAL DUAL ACTION PALM SANDER - BODY ONLY

- Three-speed settings gives control to complete various tasks.
- Features a self-contained dust extraction port with dust collection bag.
- Fitted with Ø125mm hook-and-loop backing pad and supplied with two sanding discs.
- **Model No. CP20VOS**
- List Price £65.95

G Ø115MM 20V 3AH CORDLESS LITHIUM-ION ANGLE GRINDER WITH 1HR CHARGER - 1 BATTERY

- Heavy-duty alloy bevel gear head with aluminium gear casing.
- Motor Power: 700W.
- No Load Speed: 10,000rpm.
- Supplied with 1 hour mains charger and battery in storage case.
- **Model No. CP20VAG**
- List Price £189.95



CP20VAG COMES WITH CHARGER AND 3AH BATTERY



H 20V LITHIUM-ION BATTERY CHARGER FOR CP20V SERIES

- Mains charger for Model No's CP20VBP2, CP20VBP, CP20VBP4.
- LED indicates status of battery from charging to full.
- Suitable for use with the CP20V Series.
- **Model No. CP20VMC**
- List Price £21.95



Ref	Model No.	Description	List Price	OUR PRICE
A	CP20VDD	20V Hammer Drill/Driver	£69.95	£47.95
B	CP20VMT	20V OSCILLATING MULTI-TOOL	£77.95	£52.95
C	CP20VID	20V 1/4"HEX DRIVE IMPACT DRIVER 180NM	£69.95	£44.95
D	CP20VIW	20V 1/2"SQ DRIVE IMPACT WRENCH 230NM	£69.95	£47.95
E	CP20VRS	20V RECIPROCATING SAW	£79.95	£52.95
F	CP20VOS	Ø125MM 20V RANDOM ORBITAL DUAL ACTION PALM SANDER	£65.95	£44.95
G	CP20VAG	Ø115MM 20V 3AH CORDLESS LITHIUM-ION ANGLE GRINDER	£189.95	£139.95
H	CP20VMC	20V LITHIUM-ION BATTERY CHARGER FOR CP20V SERIES	£21.95	£16.45

BATTERIES



Model No.	Battery	List Price	OUR PRICE
CP20VBP2	20V 2AH LI-ION	£52.95	£35.95
CP20VBP	20V 3AH LI-ION	£79.95	£49.95
CP20VBP4	20V 4AH LI-ION	£92.95	£62.95

Our one battery fits all system helps you to keep costs low, allowing you to buy the bodies on their own and reduce the amount of extras that you have to purchase, such as additional batteries and chargers. Alternatively, you can purchase one of the combos below for even further savings!

Lithium
RECHARGEABLE



ONE
BATTERY
FITS ALL

CP20V - DRILL & IMPACT DRIVER KIT

- 1 x CP20VDD Hammer Drill/Driver
- 1 x CP20VID Impact Driver
- 2 x CP20VBP2 2Ah Lithium-Ion Batteries
- 1 x CP20VMC Battery Charger
- 1 x CP1200CB Canvas Bag.
- Package Model No. CP20VDDCOMBO
- Total Package List Price £285.70



INCLUDES CANVAS
BAG CP1200CB

ONLY
£159.95

**BUY TOGETHER AND
SAVE £39.25**

ONE
BATTERY
FITS ALL

Lithium
RECHARGEABLE



CP20V - 3 TOOL COMBO KIT

- 1 x CP20VDD Hammer Drill/Driver
- 1 x CP20VIW 1/2" Sq Drive Impact Wrench
- 1 x CP20VAG Ø115mm Cordless Angle Grinder
- 2 x CP20VBP 3Ah Lithium-Ion Batteries
- 1 x CP20VMC Battery Charger
- 1 x CP1200CB Canvas Bag
- Package Model No. CP20VCOMBO1
- Total Package List Price £427.75



INCLUDES CANVAS
BAG CP1200CB

ONLY
£249.95

**BUY TOGETHER AND
SAVE £120.20**

ONE
BATTERY
FITS ALL

Lithium
RECHARGEABLE

**BUY TOGETHER AND
SAVE £142.60**



CP20V - 5 TOOL COMBO KIT

- 1 x CP20VDD Hammer Drill/Driver
- 1 x CP20VIW 1/2" Sq Drive Impact Wrench
- 1 x CP20VAG Ø115mm Cordless Angle Grinder
- 1 x CP20VRS Reciprocating Saw
- 1 x CP20VOS Ø125mm Orbital Palm Sander
- 2 x CP20VBP 3Ah Lithium-Ion Batteries
- 1 x CP20VMC Battery Charger
- 1 x AP8250 Large ABS Toolbox
- Package Model No. CP20VCOMBO2
- Total Package List Price £598.15



INCLUDES LARGE TOOLBOX
AP8250

ONLY
£349.95

CAMSHAFT HOLDING TOOLS MERCEDES-BENZ V6 & V8

- Vehicle applications include V6 and V8 petrol engines
- **Models:** Class C, CL, E, G GL, M, R, S, CLS, GLC, GLE, GLS, SLK, SLK
- **Engine codes include:** V8 M157 5.5L, V8 M276 3L, V6 M278 4.7L petrol engines
- Equivalent to OEM 276589014000
- Designed to be used in accordance with OEM instructions

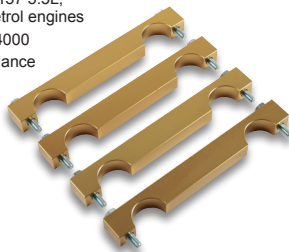

7315 NEW

ONLY
£59.95

CRANKSHAFT PULLEY HOLDING TOOL BMW

- **Applications:** BMW 3 series E46 (98-07) engine and BMW 5 series E39 (96-03) engine
- **Engine applications:** BMW 318D, 318TD, 320D, 520D, engine code M47 (20 4D 1)
- Equivalent to OEM 11 6 310 (11 6 311 holder, 11 6 312 centring tube)
- **M10:** 40Nm + 120° and **M18:** 100Nm + 150°
- Centring tube OD diameter 60mm, ID diameter 49mm

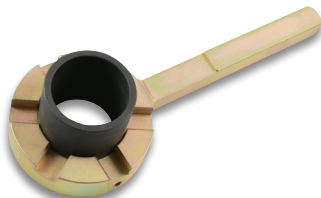

7422 NEW

ONLY
£69.95

CLUTCH RETAINING TOOL VAG

- This tool is used to assist in the removal and fitting of the multi-plate clutch stack when working on the DSG 02E 6 speed transmissions used across the VAG ranges
- **Application:** VAG DSG 02E 6 speed vehicles including Golf, Touran, Audi A3 manufactured from 2004 onwards and Audi TT from 1999 onwards
- Equivalent to OEM T10303 retaining tool
- Use in accordance with OEM instructions
- Blackened finish

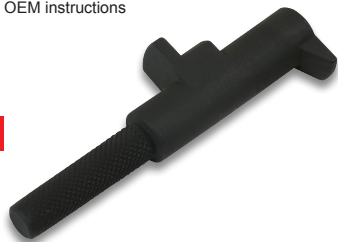

7367 NEW

ONLY
£16.95

CRANKSHAFT HARMONIC BALANCER HOLDING TOOL MERCEDES-BENZ 1.6L | 1.8L

- **Applications include:** Mercedes-Benz C, CLC, E, CLS, SLK, CLK Class, Sprinter
- **Engine applications:** 1.6L, 1.8L petrol. Engine codes 271 xxx
- Equivalent to OEM 230 589 00 40 00
- Vehicles covered range from 2002 to 2018
- For timing tools see Laser Part No. 6302, for flywheel plate locking tool see Part No. 4706



7458 NEW

ONLY
£69.95

CAMBELT PRE-TENSION TOOL VAG

- **Applications:** VAG vehicles fitted with 1.2L and 1.4L engines including Volkswagen Golf and Audi A3 from 2013 onwards
- Equivalent to OEM T10487
- For engine timing tools see Laser Part No. 6586
- Use in accordance with OEM instructions



7406 NEW

ONLY
£9.95

CRANKSHAFT FRONT OIL SEAL TOOL VAG TDI

- Application VAG SQ7 4.0 TDI
- Engine codes CZAC
- Equivalent to OEM T40320/3

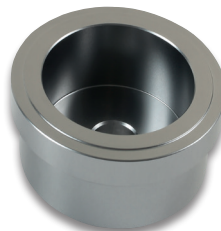

7462 NEW

ONLY
£23.95

DUAL CLUTCH ALIGNMENT TOOL BMW

- For BMW vehicles fitted with 7 speed DCT transmission (transmission code GS7D36SG)
- **Applications:** 2008-14 M3, 135i, 135iS, F82-M4, F10-M5, and F12/F13-M6
- Use to align the clutch plates for removal from the gearbox case. Tool must be fully inserted into clutch plate unit before expansion
- Equivalent to OEM 23 0 400
- Use in accordance with OEM instructions

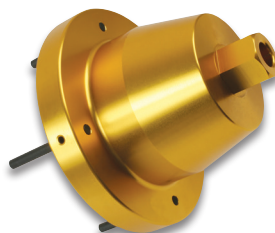

7275 NEW

ONLY
£89.95

CRANKSHAFT PULLEY HOLDING TOOL MERCEDES-BENZ

- **Vehicle applications include:** Mercedes-Benz C, CLC, E, CLS, S, SLK, CLK, SL, GLK, M Class, Viano, Vito, Sprinter
- Vehicles covered range from 2004 to 2014
- **V6 engine applications:** 2.5L, 3.0L, 3.5L. Engine code 272 xxx
- **V8 engine applications:** 4.7L, 5.5L. Engine code 273 xxx
- ID 85mm, OD 115mm/120mm, 4 x 25mm indents



7459 NEW

ONLY
£59.95

FRONT CRANKSHAFT SEAL REMOVER/INSTALLER SET BMW

- Vehicle applications include: BMW 1, 2, 3, 4, 5 Series, Z4, X1, X3, X4, X5
- Engine code applications include: N20 and N26 2L petrol engines
- Equivalent to OEM 2 212 822, 11 0 371, 11 0 372, 11 9 231, 11 9 233
- For crankshaft locking/holding tools please see Laser Part No. 6111
- For engine timing see Laser Part No. 6173



7457 NEW

ONLY
£129.95

CENTRE LOCK WHEEL NUT SOCKET PORSCHE

- Centre lock wheel nut socket with 15 teeth profile
- **Application:** Porsche 991, Cayman, Panamera
- 3/4" D
- Manufactured from high grade Aluminium
- Not to be used with an impact gun



7339 NEW

ONLY
£84.95

FUEL TANK LOCKING RING TOOL PSA

- **Application:** Citroën/Peugeot
- Designed for removing and installing the fuel tank locking rings
- 1/2" D or can be used with a 21mm wrench or socket

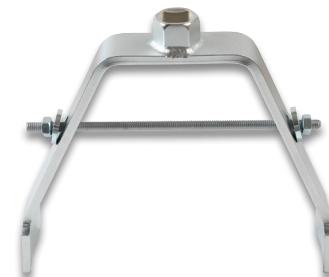

7303 NEW

ONLY
£29.95

TIMING CHAIN GUIDE RAIL PINS REMOVER MERCEDES-BENZ

- **Applications:** A Class, B Class, C Class, E Class, GLA
- Petrol 1.6L | 2.0L engines from 2011 to 2018
- **Engine codes include:** 270 XXX, 133 XXX, 274-XXX
- Equivalent to OEM 270 589 01 33 00, 605 589 00 33 00



7488 NEW

ONLY
£64.95

SHORT CIRCUIT DIAGNOSTIC KIT 16PC

- **Contents include:** 7 standard blade manually resettable circuit breaker fuses and 7 mini blade manually resettable circuit breaker fuses
- **Fuse ranges:** 5A, 7.5A, 10A, 15A, 20A, 25A, 30A
- 300mm (12") extension loop leads for better access. Both blade sizes
- For resettable standard fuse kit only see laser Part No. 7387 8pc kit
- Ideal for use with Laser Part No. 6551 digital amps clamp

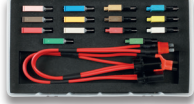

7386 NEW

ONLY
£59.95



FUEL LINE DISCONNECT SET DIFFICULT ACCESS

- **Applications:** Chrysler, Fiat, Ford, Jeep, VAG, Vauxhall/Opel and Volvo
- For disconnecting quick connect couplings on fuel lines
- Designed for use in areas of difficult access
- Design allows use on connectors that are close to sharp bend (i.e. fuel filter top pipes)
- Saves time when replacing fuel filters



7262 NEW

ONLY
£9.95

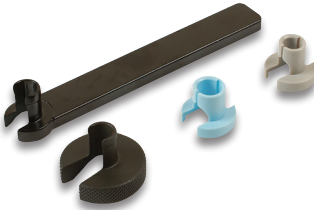

HOSE CLIP FITTING TOOL

- For clips used on Audi 2011 onwards, Volkswagen Polo, Skoda Rapid, Seat Ibiza 2013 onwards
- Application for clipless pre-opened spring band clamps
- Equivalent to OEM VAS 531 001
- Can be used in restricted areas



7456 NEW

ONLY
£11.95

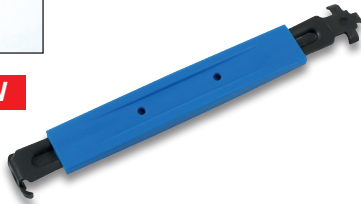

OIL FILTER WRENCH 84MM x 15 FLUTES

- Application across the Hyundai and Kia 2L and 2.2L common rail diesel engines
- **Model applications include:** Hyundai i30, Sante Fe, Sonata, Tucson, Kia Carens, Cee'd, Magnetis, Sportage
- Aluminium construction with 1/2"D and Hex drive options
- Suitable for OEM filter 26310-27420

7259 NEW

ONLY
£9.95



SHORT CIRCUIT DIAGNOSTIC KIT 8PC

- **Contents include:** 7 manually resettable circuit breaker standard blade fuses and 300mm extension loop lead
- **Fuse ranges:** 5A, 7.5A, 10A, 15A, 20A, 25A, 30A
- 300mm (12") extension loop lead for better access
- For resettable mini fuses see Laser Part No. 7386 16pc kit
- Ideal for use with Laser Part No. 6551 digital amps clamp

7387 NEW

ONLY
£32.95



FUEL LINE PLIERS FOR DIESEL FILTER

- Fuel line pliers for Multijet JTD diesel filters
- **Applications:** Alfa Romeo, Citroën, Fiat, Ford, Lancia, Opel, Peugeot and Suzuki
- Spring loaded handles
- Double jaw
- Overall length 225mm

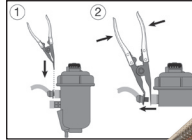

7269 NEW

ONLY
£15.95



OIL FILTER SOCKET 30MM | 3/8"D

- **Applications Include:** Volkswagen Polo from 1995, Golf from 1992, Seat Ibiza from 1993, Skoda Fabia from 1999, when fitted with 1.4 16v petrol engines
- 3/8"D
- Low profile length 30mm
- Manufactured from black finished Chrome Vanadium

7257 NEW

ONLY
£9.95



SHOCK ABSORBER TOOL SET 24PC

- 24 essential tools for repairing and replacing shock absorbers
- 6 x 80mm long sockets 16mm, 17mm, 18mm, 19mm, 21mm, 22mm and 6 x 180mm long 16mm, 17mm, 18mm, 19mm, 21mm, 22mm
- 2 x 3/8"D adaptors 90/190mm long
- **6 bits x 30mm long:** Hex H5, H6, H7, H8, Star T50, Spline M10 and 4 nut drivers Hex H10 and Metric 5mm, 6mm, 8mm
- Set manufactured from Chrome Vanadium and the bits manufactured from S2 material

7404 NEW

ONLY
£179.95



FLARE NUT WRENCH SET 1/4"D

- **7 x flare nut wrenches x 1/4"D:** 7mm, 8mm, 10mm, 11mm, 12mm, 13mm, 14mm
- Plus 145mm flexi-bar and 75mm extension bar
- Manufactured from Chrome Molybdenum
- Supplied in EVA foam for storage

7294 NEW

ONLY
£42.95



HOSE CLAMP PLIERS DOUBLE JOINTED | 430MM

- Special angle jaws make it suitable for a variety of ring and flat band hose clamps
- Capacity 0-50mm with extended length 430mm
- Double jointed feature means it is useful in tight areas
- Position lock keeps the hose clip spread open
- Spring assisted handle



7397 NEW

ONLY
£37.95



OIL FILTER WRENCH 67MM x 14 FLUTES

- Application across the Hyundai and Kia 1.0/1.1/1.2/1.3/1.4 engine ranges
- **Model applications include:** Hyundai Amica, Getz, i10 and i20, Kia Carens, Cee'd, Picanto, and Rio
- Aluminium construction with 1/2"D and Hex drive options
- Designed specifically to fit OEM filter 26300-0250

ONLY
£8.95

7258 NEW



ADJUSTABLE PIN WRENCH SET

- **Applications:** car bearing and shock absorber fixings found on some suspension and engine systems, various SAC clutch and transmission applications
- Also motorcycle suspension adjustments, head race bearing fixings, bearing securing caps, small pulley/timing sprocket holding
- Plus HGV/agriculture hydraulic ram seal caps, machine covers, castellated tube and pipe fixings etc
- Interchangeable pins, length 245mm, capacity 20-200mm, divider type adjustment controlled from a central screw. **Pin sizes:** 2.5 | 3 | 4 | 5 | 6 | 7 | 8 | 9mm diameter
- Manufactured from Chrome Vanadium with chromed finish

7412 NEW

ONLY
£79.95



JUMP STARTER MULTI-FUNCTION

- Capacity 2220mAh will start diesel engines up to 3.5L and petrol engines up to 4.5L
- Can also be used as a power bank for a laptop/phone, includes 2 USB ports, 2 to 2 USB cable and 2 smart jumper clamps
- Start current 350A, peak current 700A, charging time approx. 3 hours with charging indicator
- Short circuit, overcharge, discharge, low voltage, reverse polarity protection
- Supplied with a storage/ carrying case



7405 NEW

**ONLY
£109.95**

FOLDING FUNNEL 100mm DIAMETER

- Folds flat - ideal for under seat storage on motorcycles
- Diameter 100mm
- Length 145mm
- Manufactured from silicon
- Heat resistant



7399 NEW

**ONLY
£5.95**

COB WORKLIGHT 15W

- Supplied with a strong magnetic base and twin universal joints plus interchangeable plugs BS and EU plus cigarette lighter adaptor
- Working time 4.5 hours (low), 2.5 hours (high) and charging time 6 hours
- Switch mode high/low/off, brightness 1200 lumens (high) and 600 lumens (low)
- CE certificated and RoHS compliant
- Spare batteries available - Laser Part No. 6761



6760

**ONLY
£69.95**

WHEEL HUB CLEANING TOOL 160mm | 1/2"D

- Equipped with 160mm cleaning disc designed for stud-less hubs with a maximum centre boss diameter of 64mm
- Ideal for cleaning the mating surface on the inside of both Steel and Aluminium wheels
- Replacement discs available - Laser Part Nos. 7134 (160mm dia. max. centre boss dia. 64mm) and 7135 (200mm dia. max. centre boss dia. 74mm)
- Can be driven by 1/2" drive power tools (only requires light contact pressure for best results)

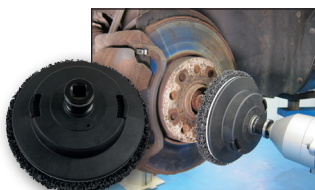

7133 NEW

**ONLY
£89.95**

MINI JUMP START POWER PACK

- Emergency starter for cars, vans, boats, forklifts, motorcycles etc.
- Will start petrol engines up to 6500cc and diesel engines up to 3000cc
- Includes two LED lights, voltage display, two USB ports 5v, British Standard plug charger, 12volt charger, 2 alligator clips with 38cm jump wire
- Size: 16.5" x 11" x 14", weight: 4.2kg
- CE certificated, conforms to FCC and UL



6994

**ONLY
£159.95**

RECHARGEABLE WORK LAMP ROTATABLE BASE

- Slim rechargeable work light with rotatable base
- 10+1 SMD LEDs
- Working time 2.5-3 hours, charging time 3-4 hours. Supplied with USB charging cable and BS mains plug
- Complete with magnet and hook
- Manufactured from Aluminium and ABS plastic
- Over charge/discharge protection
- CE certificated, RoHS compliant



6871 NEW

**ONLY
£32.95**

ANTIFREEZE TESTER PROPYLENE GLYCOL

- Easy to read indicator and designed for modern Propylene Glycol antifreeze
- Number of floating discs measures the level of coolant protection
- Tests at hot and cold temperatures
- Reads in Celsius and Fahrenheit
- Bulb is green, 5 discs



4292

**ONLY
£6.95**

DIGITAL MULTI-FUNCTION TESTER

- Three-in-one multi-function tester powered by micro processor
- Includes tyre pressure gauge with function to record the readings. Select PSI, bar or kg
- LED work light
- Battery tester: low/mid/full
- Alternator tester: low/charge/over charge
- Powered by 2 x AAA batteries (supplied)
- CE certificated, RoHS compliant



6378

**ONLY
£19.95**

SOLDERING IRON RECHARGEABLE | 12W

- Supplied with safety stand, 1m USB cable to micro USB cable and LED light
- 12 watt, charging time 3.5 hours, run time approx. 90 minutes
- Charging protection
- Reaches working temperature 356°F in 10 seconds, maximum temperature 932°F



7336 NEW

**ONLY
£59.95**

COB WORKLAMP 2W

- Built in USB charger - powered by built in 2200mAh Li-ion battery
- Fitted with two magnets: base and back plus hanging hook
- Brightness 220 lumens, working time 4.5 hours, charging time 5 hours
- CE certificate and RoHS compliant
- Size: 160mm x 50mm x 40mm



7057

**ONLY
£19.95**

ANTIFREEZE TESTER ETHYLENE GLYCOL

- Easy to read indicator and designed for the popular modern Ethylene Glycol antifreeze. Suitable for use on OAT (organic acid technology) antifreeze
- Number of floating discs measures the level of coolant protection
- Tests at hot and cold temperatures
- Reads in Celsius and Fahrenheit
- Floating orange disc shows over protection and loss of efficiency. Bulb is black, 6 discs



4293

**ONLY
£6.95**

HEADLIGHT RESTORATION KIT

- Repairs oxidised and scratched plastic headlight lenses
- Contents include: 2 x 40g polish paste, 2 x 3ml UV adhesive, 1 x masking tape, 1 x orange sponge pad, 1 x white sponge pad, 6 x sandpaper, 1 x hand polisher
- RoHS approved
- REACH compliant



77153 NEW

**ONLY
£10.95**

ASSORTED AIR CON O RINGS 225PC

- Green HNBR (hydrogenated nitrile butadiene rubber)
- **Contents: 20 pieces of each:** 3mm x 1mm, 4mm x 1mm, 4.5mm x 2mm, 5mm x 2mm, 6mm x 2mm, 6mm x 2.5mm, 6mm x 3mm, 7mm x 2mm, 8mm x 2mm
- **Contents: 5 pieces of each size:** 9mm x 2mm, 10mm x 2mm, 12mm x 3mm, 13mm x 3mm, 4mm x 2.5mm, 17mm x 2.5mm, 18mm x 4mm, 20mm x 2mm, 22mm x 2mm
- Supplied in a plastic box



ONLY
£22.95 **35162 NEW**

ASSORTED FUEL PIPE CONNECTOR KIT INCLUDING TOOL

- Kit includes 70 x fuel pipe quick connectors, 12 x straight couplings, twin-eared O clips and pipe cutter
- Nylon pipe in 3 IDs, 2 x 6mm ID x 340mm, 6 x 8mm ID x 340mm, 2 x 10mm ID x 340mm
- **Rubber hose:** 3 x 7.5mm ID x 200mm, 1 x 12mm ID x 200mm
- Plus Laser Part No. 6933 - insertion tool in a cut foam



37199
ONLY
£229.95

OVERBRAIDED FUEL LINE HOSE 3.5MM ID | 5M

- Manufactured to DIN 73379 Type B
- Oil and fuel resistant black rubber
- **Temperature range:** -40°C to +85°C
- 5m coil



30938
ONLY
£9.95

POWER CONNECTORS ANDERSON TYPE PLUG 175 AMPS

- Grey Anderson type plug
- Suitable for cables up to 60mm²
- Comes complete with 2 terminals
- Please use Laser Part Nos. 6615 and 6922 to crimp terminal lugs on to cable

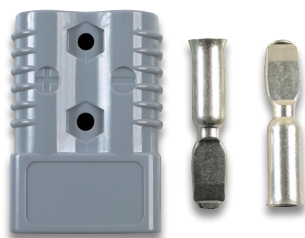

30087 NEW
ONLY
£12.95

MICRO FIBRE YELLOW CLOTHS IN DISPENSER BOX

- Multi-purpose cleaning cloth that traps dust and debris. Perfect for the garage and workshop to clean and trap dirt without leaving smears or damaging paintwork. Ideal for the professional bodyshop
- Dispenser box enables cloths to be taken at ease when required and keeps cloths away from a workshop environment until required
- 30cm x 30cm
- **Material:** 80% Polyester, 20% Polyamide. Washable and reusable over and over again
- Dispenser box of 50 cloths



37310 NEW
ONLY
£24.95

ASSORTED COMMON RAIL DIESEL INJECTOR WASHERS

- Popular assortment
- Sizes from 13.8mm to 15mm
- Various thicknesses
- Top up packs available
- Box of 150 pieces

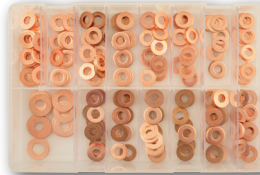

34999
ONLY
£39.95

OVERBRAIDED FUEL LINE HOSE 3.2MM ID | 5M

- Manufactured to DIN 73379 Type B
- Oil and fuel resistant black rubber
- **Temperature range:** -40°C to +85°C
- 5m coil



30944
ONLY
£9.95

POWER CONNECTORS ANDERSON TYPE PLUG 350 AMPS

- Grey Anderson type plug
- Suitable for cables up to 70mm²
- Comes complete with 2 terminals
- Please use Laser Part Nos. 6615 and 6922 to crimp terminal lugs on to cable



30088 NEW
ONLY
£22.95

ASSORTED BOX OF SOLDER TYPE HEATSHRINK CONNECTORS 48PC

- Replacement terminals for Laser Part No. 6616
- **Box contents:** 20 x red (0.5-1mm) terminals. Replacement top up pack Part No. 30692
- 16 x blue (1.5-2.5mm) terminals. Replacement top up pack Part No. 30694
- 12 x yellow (4-6mm) terminals. Replacement top up pack Part No. 30696
- Box contains 48pc



ONLY
£34.95 **37188**

ASSORTED POPULAR FUEL LINE CONNECTORS 85PC

- Assortment contains 8 popular common rail fuel connectors
- **Contents:** 5 x T type connectors (34021), 10 x L type connectors (34022), 15 x 102° connectors (34023), 15 x 90° connectors (34024), 10 x offset connectors (34025), 10 x T type connectors (34026), 15 x 90° connectors (34027), 5 x snap lock Delphi type connectors (34028)
- All the connectors have a Viton FKM seal O ring



34039 NEW
ONLY
£46.95

POWER CONNECTORS ANDERSON TYPE PLUG 50 AMPS

- Grey Anderson type plug
- Suitable for cables up to 16mm²
- Comes complete with 2 terminals
- Please use Laser Part Nos. 6615 and 6922 to crimp terminal lugs on to cable

30086 NEW
ONLY
£5.95

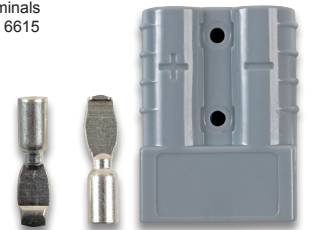

BATTERY TERMINAL CRIMPING TOOL HD

- Heavy duty
- Essential for replacing or repairing battery terminals without the need for a vice
- Length 570mm
- Weight 3.2kg, Jaws 10-120mm²
- Non-insulated
- For lighter weight crimping tool - Laser Part No. 6922



6615
ONLY
£99.95

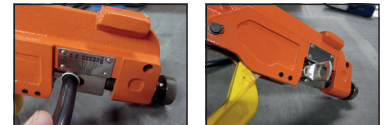

20PC LOCKING WHEEL NUT KEY SET - VAUXHALL A SET

- 20pc set supplied in a sturdy storage case
- **Applications include:** Agila, Astra F/G/H, Calibra, Corsa B/C/D, Meriva, Omega B, Signum, Speedster, Tigra A/B, Vectra B/C, Zafira A/B
- DO NOT USE IMPACT TOOLS



Part No: JESM1020/AJ

ONLY
£109.99

20PC LOCKING WHEEL NUT KEY SET - VAUXHALL B SET

- 20pc set supplied in a sturdy storage case
- **Applications include:** Agila, Astra F/G/H, Calibra, Corsa B/C/D, Meriva, Omega B, Signum, Speedster, Tigra A/B, Vectra B/C, Zafira A/B
- DO NOT USE IMPACT TOOLS



Part No: JESM1021/AJ

ONLY
£109.99

20PC LOCKING WHEEL NUT KEY SET - VAUXHALL C SET

- 20pc set supplied in a sturdy storage case
- **Applications include:** Agila, Astra F/G/H, Calibra, Corsa B/C/D, Meriva, Omega B, Signum, Speedster, Tigra A/B, Vectra B/C, Zafira A/B
- Do not use with impact tools



Part No: JESM1022/AJ

ONLY
£109.99

MASSIVE SAVING - BUY ALL THREE KITS FOR JUST £285.00 AND SAVE £45.00

3/8" DR. FLEXIBLE LOCK LOW PROFILE RATCHET

- Precise 80 tooth ratcheting drive
- The low profile design and 180° flexi head design with push lock allows for use in awkward and confined spaces
- Anodised blue ratchet spinner low profile socket adapters, 3/8" female to 1/2" & 1/4" male
- Quick release mechanism
- Flip switch for forward/reverse use
- Full length of ratchet: 234mm
- Made from Chrome vanadium steel



ONLY
£27.99

Part No: JESM0384/AJ

43PC 1/4", 3/8" & 1/2" DR. TRX-STAR/TAMPER PROOF, HEX & E-SOCKET SET

Part No: JESM0044/AJ

- Drop-Forged chrome vanadium steel sockets with S2 steel TRX-Star* bits
- Sockets heat treated and chrome plated for resistance to corrosion
- Mirror finish with knurled ring to assist gripping with oily fingers
- Supplied in slim line storage case

- **22pc 1/4" Dr.**
 - Hex 2.5 - 3 - 4 - 5 mm x 38 mm
 - TRX-Star T8 - T10 - T15 - T20 - T25 - T27 - T30 x 38mm
 - Tamper TRX-Star T10 - T15 - T20 - T25 - T27 - T30 x 38mm
 - E-Socket E4 - E5 - E6 - E7 - E8 x 23 mm

- **15pc 3/8" Dr.**
 - Hex 6 - 7 - 8 - 9 mm
 - TRX-Star T40 - T50 - T47 - T50
 - Tamper TRX-Star T40 - T45 - T50
 - E-Socket E10 - E12 - E14 - E16 x 28mm

- **6pc 1/2" Dr.**
 - Hex 10 mm
 - TRX-Star T55 - T60
 - Tamper TRX-Star T55 - T60
 - E-Socket E18 x 38 mm - E20 x 40 mm

ONLY
£48.99



LED/UV COB LED FOLDING INSPECTION LAMP

- 500 Lumen 5W COB LED
- UV Torch in the head
- 270° Rotating head for angling the light
- Magnetic base plus hanging hook
- USB rechargeable
- IP54 water resistant



INCLUDES
UV LIGHT
ON EDGE
OF LAMP



Part No: JESPLHP1
GSF Part No: 987AA2000

ONLY
£29.95

30PC XI-ON DEEP SOCKET SET 3/8" & 1/2" DR

- Ideal for releasing rounded nuts worn up to 85%
- Set includes 3/8" and 1/2" Dr. sockets, various sizes between 4-32mm
- Innovative design allows increased contact area with nut
- Torque is spread evenly over the nut when force is applied to reduce stress and damage to the Hex point
- Conforms to ANSI and DIN standards



ONLY
£64.99 Part No: JESM0030/AJ

7PC WHEEL LOCKING NUT KEY SET - VAUXHALL D

- 7pc set supplied in a sturdy storage case made up of the seven keys with a 4 digit code
- Applications include Agila, Astra F/G/H, Calibra, Corsa B/C/D, Meriva, Omega B, Signum, Speedster, Tigra A/B, Vectra B/C, Zafira A/B
- For use with a conventional 17mm wheel nut socket and power bar
- Do not use with impact tools



Part No: JESM1023/AJ

ONLY
£46.99

SCREW EXTRACTOR SET 6PC 3/8" SQ DRIVE

• Contents: 2, 3, 4, 6, 8, 10mm

- Designed to remove broken bolts and studs without damaging the casing
- Manufactured from heat treated Chrome Molybdenum steel
- Reverse thread spiral design for maximum grip, with recommended drill bit size (for pilot hole) etched on each extractor
- Suitable for use with 3/8" Sq drive ratchets
- Supplied in storage case



Part No: JESM2006/AJ

ONLY
£14.99

6PC HEAVY DUTY SHOCK ABSORBING GUN AIR HAMMER KIT

- Removal of seized suspension parts
 - Shock absorbing Impact system allows controlled application of force via an air powered hammer
 - Allows the control to gradually increase the force being applied, in order to loosen seized components
 - Built-in shock-absorber feature in order to minimise risk of damage
 - Low vibration for user comfort
 - Supplied with a set of five impact hammers for variable applications
 - Can also be used on any seized or rusted nuts/bolts anywhere
- Minimum Speed:** 2200 RPM
Maximum Speed: 2640 RPM
Shank Opening: 0.401"
Stroke: 3 - 3/4"

Bore Dia: 3/4" (19mm)
Air Inlet: 1/4" NPT
Air Pressure: 90 PSI (6.3 BAR)
Air Hose: 3/8"
Air Consumption: 4CFM / 0.03m³/min
Sound Pressure: 107dBA
Sound Power: 116dBA
Vibration: 2.9m/s²

Part No: JESM2007/AJ

ONLY
£159.99



3PC SOFT TIP AIR HAMMER SET

- Soft tip air hammer add on set for the JESM2007/AJ
- **The 3pc tip set includes:**
 - Aluminium tip
 - Brass tip
 - Nylon tip



Part No:
JESM2003/AJ

ONLY
£28.99

20" DEADBLOW HAMMER



- For knocking wheels off that have seized to the hub
- Filled with steel shot that absorbs the shock if the impact, does not rebound on impact
- Soft convex face made from Polyurethane material
- Heavy duty handle with grooved safety grip
- 20" Length



Part No: JESM9920/AJ

ONLY
£39.99

30" DEADBLOW HAMMER



- For knocking wheels off that have seized to the hub
- Filled with steel shot that absorbs the shock if the impact, does not rebound on impact
- Soft convex face made from Polyurethane material
- Heavy duty handle with grooved safety grip
- 30" Length



Part No: JESM9930/AJ

ONLY
£45.99

1/2 DR. BREAKER BAR WITH HANDLE

- 24" length, hardened and tempered Chrome Vanadium bar
- Highly polished finish for ease of cleaning
- Comfort handle for an improved grip
- Durable, swivel knuckle head with spring-ball socket retention and black phosphate finish
- Replacement, easy to fit knuckle head available (JESM7300RK/AJ)



Part No:
JESM7200/AJ
GSF Part No:
987AJ1380

ONLY
£17.99



**REPLACEMENT
KNUCKLE FOR
JUST £5.50**

Part No:
JESM7300RK/AJ
GSF Part No:
987AJ1390

4PC VORTEX GEAR WRENCH SET

- The 'Vortex' design completely fits the head of a bolt
- Grip and work on bolts up to 80% rounded
- Made from Chrome Vanadium hardened steel, tempered with a polish finish for corrosion resistance
- Supplied in a tetron divided wallet with pockets for each wrench and with strengthened eyelets for hanging

The double ended ratcheting wrench set sizes include:

- 8" & 10"
- 12" & 13"
- 14" & 15"
- 17" & 19"



Part No:
JESM2604/AJ

ONLY
£63.99

5PC V-BELT & TIMING BELT PULLEY WRENCH SET

- For use on tensioners or timing and auxiliary pulleys
- 12 Point Drive spanner wrench
- **Sizes:** E13 / E15 / E16 / E17 and E19
- 45 degree offset ends allow you to reach all areas in the engine bay
- Manufactured from CR-MO steel for strength and durability
- Rubber ergonomic slip guard handles for comfort and grip



Part No:
JESM2605/AJ

ONLY
£35.99



GREEN LED RECHARGEABLE POCKET LIGHT

- 24 SMD-LEDs provide a bright and impressive output
- Two brightness settings (half and full)
- Luminous flux approximately 220lm
- Approximately 1.5 hours (full-bright) or 3 hours (half-bright) run time
- Adjustable magnetic support
- On/off button on rear of casing
- Carry strap and AC adapter included
- 3.7V 1100mAh Li-Polymer battery
- 2.5 to 3 hours charging time
- Available in three colours



Part No: JESPL-1001G/AJ
GSF Part No: 987AJ0110



ONLY
£16.99

COB LED ALUMINIUM WORK LIGHT

- 500 Lumen White COB LED
- Additional 45 Lumen Red LED with SOS flash function
- Strong Aluminium construction
- Convenient USB rechargeable
- Strong magnetic base
- Pull-out pocket clip
- Easy press tactical switch
- Micro-USB charging cable and charging dock included
- Plus 'magic' magnetic USB charging cable included
- 3.7V 2200mAh 18650 Li-ion Battery (included)
- **Charging Time:** approx 4 hours via mains power
- **Weight:** 265g (with battery)

ONLY
£24.95

Part No: JESPL500
GSF Part No: 987AA1990



120 PC 3528 SMD LED UNDERBONNET WORK LIGHT

- The underbonnet worklight comes in a telescopic adjustable holder that can extend from 1.2m to 1.95m
- The worklight also comes with magnetic swivel end caps enabling the lamp to be attached to any metal surface
- Also fitted with an under bonnet hanger for attaching to car bonnets
- Lamp unit can swivel 120° in its holder and has a 60 LED function for longer battery life

- Lithium 7.4v 2000mAh 5-6 hours (max) charging time
- Supplied with BS approved 3 pin 230V charger



Part No: JESPL-120/AJ
GSF Part No: 987AA0820

ONLY
£49.95

CV BOOT BAND CUTTERS

- Specially designed tip to easily cut stainless steel clamps without damaging the CV boot
- Spring loaded action handle with handle lock
- Heat treated steel jaws
- PVC dipped handles for comfort
- 8.5" (216mm) in length



ONLY
£13.99

Part No: JESM9411/AJ
GSF Part No: 987AJ0350

60PC 3/8" & 1/2" DR. PROF. BIT SET

Driver and security bit set

Part No:
JESM0060/AJ

ONLY
£43.99



- 30mm and 75mm lengths
- Phosphate coated, chrome vanadium steel bits
- Unique, shock absorbing 10 & 14mm Hex Buffer Adaptor
- **Set includes:**
- Tx-Star / Spline (30mm and 75mm) - T20, 25, 27, 30, 40, 45, 50, 55, 60 & M5, 6, 8, 10, 12
- Spline (75mm) - M9, M14, (Spline Temper - M16)
- Hex (30mm and 75mm) - H4, H5, H6, H7, H8, H10, H12
- Hex (30mm) - H14, H17 (VAG Group vehicles)
- Hex (75mm) - H9, H9.5
- Ribe (75mm) - RM6, RM7, RM8, RM10, RM12
- Square (75mm) - 8mm and 10mm
- 10mm and 14mm Hex Buffer Adaptor
- 3/8" Sq Dr. 10mm Hex Bit Adaptor
- 1/2" Sq Dr. 10mm and 14mm Hex Bit Adaptors

43PC 1/4 3/8 1/2 DR. XI-ON SOCKET SET

- Ideal for releasing rounded nuts worn up to 85%, compared to conventional sockets
- Set includes 1/4", 3/8" and 1/2" Dr. sockets, various sizes between 4-32mm
- Innovative design allows increased contact area with nut to reduce rounding
- Torque is spread evenly over the nut when force is applied to reduce stress and damage to the Hex point, extending the life of the nut
- Conforms to ANSI and DIN standards

SPREADS TORQUE EVENLY

ONLY
£55.00

Part No:
JESM0043/AJ

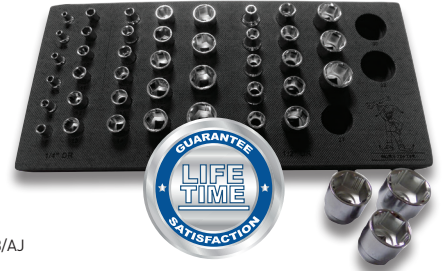

REAR AXLE BEAM BUSH REMOVAL / INSTALLATION TOOL SET

- For the removal & installation of the rear axle beam bush
- On car solution - no need to remove the suspension arm and braking system to change the bush
- Suitable for Ford Fiesta MK6 (2008-), Mazda 2 MK3 (2007-)
- All force screw threads, nut and bolts should always be lubricated with Molybdenum Disulphide grease
- Supplied in carry case



Part No: JESM3235/AJ

ONLY
£55.99



33PC COOLING SYSTEM AND RADIATOR CAP MASTER KIT WITH AIRVAC COOLANT REFILLER

- Most comprehensive kit in the market place
- Tests automotive pressurised cooling systems up to 35psi
- Allows quick and easy identification of internal and external leaks
- High-powered hand pump with colour-coded pressure gauge, thumb operated pressure release valve and quick-release coupling
- Includes a selection of 25 adaptors with quick-release couplings for servicing (application guide included)
- Airvac Coolant Refiller purges trapped air from the cooling system
- 4 conical bushes, 600mm extension tube and 1300mm water feed tube for use with the Airvac Coolant Refiller

Part No: JESM3232/AJ

ONLY
£164.99

3PC 1/2" DR. COLOUR CODED IMPACT WHEEL NUT SOCKET SET

- Up to five times stronger than the conventional design and tested to 500Nm
- New design incorporates a protective metal colour-coded support ring that prevents the socket wall spreading
- Each socket has a protective sleeve and an insert which prevents damage to the alloy wheels and nuts
- 85mm socket length
- **3 sizes:** 17mm / 19mm / 21mm



ONLY
£23.99

Part No: JESM3323/AJ

TWO WAY OIL FILTER WRENCH

Dual action - can be used with both a 3/8" and 1/2" drive tool

- Removes and tightens most metal oil and fuel filters from 2.5" to 4" in diameter
- Claw type grip
- Use with 3/8" or 1/2" square drive tools
- Grips filter tighter as more torque is applied to the wrench
- Three Mid-Carbon legs
- Chrome Molybdenum centre gears



ONLY
£6.99

Part No: JESM9413/AJ

5PC 3/8" DR. OIL FILTER CAP OFFSET WRENCH SET

- Offset drive and low profile design for paper cartridge style oil filters
- For use with 3/8" Dr. wrench
- Supplied on a storage rail
- **Sizes:** 24mm / 27mm / 32mm / 36mm / 38mm



Part No: JESM9425/AJ

ONLY
£16.99



SELF ADJUSTING CLUTCH (SAC) MASTER TOOL KIT

- Unique single piece, six arm clamping plate
- 37pc specialist service tool kit for the professional disassembling and assembling of all self-adjusting clutches (SAC)
- Prevents plate distortion
- The single piece, six arm plate has been designed for SAC clutches with 6/8 locking holes
- **Set includes:**
- Six arm clamping plate with compression strut and handle
- Clutch resetting tool to reset the adjustor ring
- Specialist 6pc clutch mandrel set for BMW models
- Face spanner for releasing the locking elements on various VAG group models
- 11pc clutch centring tool set
- Various sized threaded bolts with knurled nuts



Part No: JESM9737/AJ

ONLY
£279.99



4PC 5L PLASTIC JUG KIT WITH MULTICOLOURED LIDS

- Manufactured from heavy duty, high grade Polythene
- Removable, flexible spout
- Dust and pollutant protection screw lid and spout cap
- Four coloured lids used to easily identify the different fluids used in a workshop
- Makes lubrication work easier, faster, safer and cleaner
- Each jug has a 5L capacity



ONLY **£21.95** Part No: JESM5004/AJ
GSF Part No: 987AA4690

16PC PUNCH & CHISEL SET

- Set includes 12 punches and 4 chisels:
- - 2 x centre punches (3 and 5mm)
- - 5 x pin punches (2, 3, 4, 5 and 6mm)
- - 5 x taper punches (2, 3, 4, 5 and 6mm)
- - 4 x cold chisels (10, 13, 16 and 19mm)
- Keep your tools neat with our newly added roll bag
- **Heat treatment:** HRC 5-58"
- **Impact point:** 35-45"
- All neatly stored in a roll bag



Part No: JESM9516/AJ
GSF Part No: 987AJ0410

ONLY **£27.99**



14PC COMBINATION SPANNER SET

- Combination spanner set made from Chrome Vanadium Steel, hardened, tempered with a satin polished finish for corrosion resistance
- Perfect for home or professional use
- Supplied in tetron divided wallet with marked pockets for each wrench and with strengthened eyelets for hanging
- **Set includes:** 8mm, 9mm, 10mm, 11mm, 12mm, 13mm, 14mm, 17mm, 19mm, 22mm, 24mm, 27mm, 30mm, 32mm



ONLY **£31.99** Part No: JESM2314/AJ
GSF Part No: 987AJ0070

29PC SELF TAPPING THREADED INSERT KIT

- For the repair and restoration of damaged threads
- The kit includes self tapping threaded inserts, thread insert holders and bit holders
- Inserts cut own thread when inserting into oversize drilled hole
- Saves time and money, with no taps needed and only having to tap once with the insert
- Extra packs of self tapping thread inserts available
- **Includes self-tapping threaded inserts:**
- - 6x1.0, 8x1.25, 10x1.25, 12x1.25, 12x1.5
- **Covering sizes:** M6, M8, M10, M12



ONLY **£47.99** Part No: JESM3029/AJ

PROFESSIONAL PNEUMATIC COIL SPRING COMPRESSOR

- Heavy Duty twin pneumatic rams
- **Maximum force:** 2400kg
- Patented 4 claw design that fits all current suspension on the market
- Triple bar cage with micro switch lock for added safety
- **Inlet pressure:** 5 to 10 Bar
- Safety retention cable
- Adjustable strut support
- **Dimensions:** 1200 x 500 x 400mm
- Weight 70kg

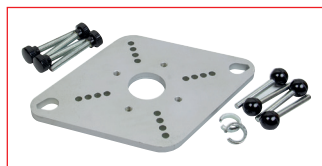

Part No: JESHDCSC



ONLY **£1,795**
Weekly from: £9.53†

13PC TURBO SYSTEM TESTER

- Test turbo system pressure and identify leaks
- Charges the turbo system by connecting a low pressure compressed air system through a suitable pressure regulator (not included)
- 6 pairs of stepped adaptors (6 x test, 6 x stop) to fit most common sizes of hose
- Adaptors are lipped to allow for better grip within the turbo hose end

Set includes:
- ø31mm / ø38mm, ø46mm / ø51mm, ø55mm / ø60mm, ø65mm / ø70mm, ø75mm / ø80mm, ø85mm / ø90mm

Part No: JESM3212/AJ

ONLY **£76.99**



29PC UNIVERSAL PRESS AND PULL SET

- Comprehensive kit for removal/installation of wheel bearings, suspension bushes and seals
- Supplied with for stepped end plates and four force screws in carry-case
- Plates and sleeves can be used in a standard workshop press
- **Sleeve wall thickness:** 5mm
- **Sleeve Height:** 94mm

- **External sleeve diameter:** 44, 46, 48, 50, 52, 54, 56, 58, 60, 62, 64, 66, 68, 70, 72, 74, 76, 78, 80, 82mm
- **Sleeve end caps:** 83x20mm
- **Force Screw Threads:** 10x1.5, 12x1.5, 14x1.5, 16x1.5mm
- **Force Screw Length:** 450mm



Part No: JESM3229/AJ

ONLY **£259.99**

SIP 1822 INFRARED DIESEL/PARAFFIN HEATER

- 230v (13amp) input supply
- 100,000 BTU/hr (35kW) heat output
- 40 litre steel-manufactured fuel tank
- Wheel-mounted for easy movement
- Adjustable tilting head for versatility
- Suitable for diesel and paraffin fuels

100,000 BTU/hr



Part No: 09312

ONLY £895.00

NEW FROM SIP

SIP FIREBALL 215XD DIESEL/PARAFFIN HEATER

- 230v (13amp) input supply
- 215,000 BTU/hr (63kW) output
- 1500m³ (52,972 cu.ft) heating area
- 6.5 litre/hour average fuel consumption
- 50 litre steel fuel tank capacity
- Thermostat and digital temperature readout
- Powder-coated finish for added durability
- Wheel-mounted for easy movement
- 12 month warranty

215,000 BTU/hr



WHILE STOCKS LAST!

Part No: 09570

ONLY £495.00



SIP PRO BOOSTER 3100 12V POWER SUPPLY

- 3100A boost peak rate
- 940A maximum cranking rate
- True 25Ah battery, 12v voltage
- 1x built-in 12v DC output socket
- Built-in reverse polarity protection
- Heavy-duty charge leads and clips
- Complete with mains fast charger
- Integrated LED charge indicators
- Ultra-tough and rugged casing
- Premium Swiss construction

Swiss Made

Part No: 07173

ONLY £325.00



SIP PRO BOOSTER 5024 12V/24V POWER SUPPLY

- 3100A boost peak rate
- 940A maximum cranking rate
- True 25Ah battery, 12v voltage
- 1x built-in 12v DC output socket
- Built-in reverse polarity protection
- Heavy-duty charge leads and clips
- Complete with mains fast charger
- Integrated LED charge indicators
- Ultra-tough and rugged casing
- Premium Swiss construction

Swiss Made

Part No: 07192PA37

ONLY £599.00



with FREE SIP Chargestar Smart 8 & SIP 10W Cree LED Rechargeable Spotlight



FREE CHARGER & LIGHT!

SIP 12V SC 8000 CAPACITOR BOOSTER

- 12v heavy-duty capacitor and booster
- Rugged build with battery-less design
- 8000A boost peak/1400A cranking rate
- Uses heavy-duty 300F Ultra capacitors
- ON/OFF switch and built-in safety fuse
- Supplied with fully automatic charger
- Premium Swiss construction

Swiss Made

Part No: 07103

ONLY £425.00



NEW FROM SIP

SIP 12V/24V SC 18000 CAPACITOR BOOSTER

- 12v/24v heavy-duty capacitor/booster
- Rugged build with battery-less design
- 18000A (12v) / 9000A (24v) boost peak
- 4400A (12v) / 3400A (24v) cranking rate
- Uses heavy-duty 360F Ultra capacitors
- ON/OFF switch and built-in safety fuse
- Supplied with fully automatic charger
- Premium Swiss construction

Swiss Made

Part No: 07107

ONLY £875.00



NEW FROM SIP

SIP 180ST-MIG TRANSFORMER WELDER

- 230v (25 amp) input supply
- 6 output power settings for versatility
- 30 - 180 amp (peak) output current
- 0.6 - 1 mm welding wire, up to 15kg
- 0.8 - 7 mm weld thickness (mild steel)
- Mild steel can weld in gas and gasless modes
- Welds aluminium and stainless steel in gasless
- Wheel-mounted with integrated bottle carrier
- Heavy-duty all-metal 2-roll wire feed system
- Ultra reliable low current performance
- Supplied with necessary accessories



LOW CURRENT PERFORMANCE

Part No: 05718
ONLY
£425.00

SIP 2 TON FOLDABLE ENGINE CRANE

- 2 Ton weight capacity
- 8 Ton ram
- 2 metre maximum crane lifting height
- 4-hole position boom for different weights:
Pos 1: 2 Ton
Pos 2: 1.5 Ton
Pos 3: 1 Ton
Pos 4: 0.5 Ton
- Heavy-duty steel box construction
- Hydraulic pump with chromed ram
- Retractable booms and front legs
- 6 castors for easy movement



Part No: 03687
ONLY
£229.95

SIP HG2300MP MIG/TIG/ARC INVERTER WELDER

- 230v (16amp) input supply
- MIG, TIG, and ARC triple function
- Infinitely variable weld output settings
- 30 - 200 amp MIG output current
- 20 - 200 amp TIG output current
- 30 - 170 amp ARC output current
- High 50% duty cycle on all processes
- 0.6 - 1 mm wire size tolerance
- 1.6 - 4 mm max. electrode size
- Built-in IGBT inverter technology
- Extra-low current performance
- Reliable performance in gas/gasless
- Easy-to-read dual digital displays
- Rugged lightweight construction



with FREE SIP Meteor 2185 Electronic Welding Headshield

TWO YEAR WARRANTY

FREE HEADSHIELD!



Part No: 05773PA37
ONLY
£545.00

SIP 500KG TRANSMISSION JACK

- 500kg maximum weight capacity
- 1175 - 1995mm lifting height
- Oversized foot pedal for easy lifting
- Spring-loaded pressure release valve
- Solid heavy-duty hydraulic cylinder
- New and improved jack design
- Knurled air release valve



Part No: 03871
ONLY
£175.00

SIP VN3/150-SB VERTICAL BELT-DRIVE AIR COMPRESSOR

- 230v (13amp) input supply
- Powerful 3hp (2.2kW) motor
- Oil-lubricated, belt-driven model
- Space-saving squat 150 litre receiver
- 13 CFM maximum piston displacement
- 145psi (10 bar) max. working pressure
- Multi-finned flywheel for added cooling
- Heavy-duty B2800 pump as standard
- Fitted with an aluminium aftercooler
- Extra-strong wire mesh belt guards
- Supplied with a pressure regulator
- Premium Italian construction

SPACE SAVING 'SQUAT' AIR RECEIVER DESIGN

Parts Alliance Exclusive Package



BUILT-IN PRESSURE REGULATOR



Part No: 06323PA37
ONLY
£750.00  **MADE IN ITALY**

SIP 1 TON TRANSMISSION JACK & ADAPTOR

- 1 Ton maximum weight capacity
- 1258 - 2145mm lift height range
- Heavy-duty footprint to spread weight
- Reliable transmission adaptor included
- Integrated spring-loaded release valve
- Mounted on four rugged swivel castors
- Heavy-duty and durable construction
- Superb value-for-money and long life



Part No: 03693
ONLY
£375.00

SIP SD1260
FLOOR SCRUBBER/DRYER
 MAINS & RECHARGEABLE POWER OPTIONS

NEW
 FROM SIP

- Part No:** 07980
SIP SD1260AC
 Mains Powered
Floor Scrubber Dryer
- 230v (13amp) input supply
 - 1260m²/h maximum working capacity
 - 370w brush motor / 400w vacuum motor
 - 360 - 440mm scrubber / squeegee width
 - 11 litre solution tank and 13 litre recovery tank
 - Brush has 130rpm speed and 18kg pressure
 - Reliable and heavy-duty mechanical traction
 - Relatively lightweight - weighs just 53kg
 - Wheel-mounted for easy movement
 - Premium Italian construction

- Part No:** 07982
SIP SD1260BAT
 Rechargeable Battery Powered
Floor Scrubber Dryer
- 12v DC power (1x 55Ah) battery power
 - Fitted with a reliable on-board charger
 - 1260m²/h maximum working capacity
 - 250w brush motor / 180w vacuum motor
 - 360 - 440mm scrubber / squeegee width
 - 11 litre solution tank and 13 litre recovery tank
 - Brush has 130rpm speed and 18kg pressure
 - Reliable and heavy-duty mechanical traction
 - Relatively lightweight - weighs just 53kg
 - Wheel-mounted for easy movement
 - Premium Italian construction

SIP SD1600
FLOOR SCRUBBER/DRYER
 MAINS & RECHARGEABLE POWER OPTIONS

NEW
 FROM SIP

- Part No:** 07984
SIP SD1600AC Mains Powered
Floor Scrubber Dryer
- 230v (13amp) input supply
 - 1600m²/h maximum working capacity
 - 400w brush motor / 700w vacuum motor
 - 450 - 540mm scrubber / squeegee width
 - 30 litre solution tank and 35 litre recovery tank
 - Brush has 150rpm speed and 18kg pressure
 - Reliable and heavy-duty mechanical traction
 - Relatively lightweight - weighs just 66kg
 - Wheel-mounted for easy movement
 - Premium Italian construction

- Part No:** 07986
SIP SD1600BAT Rechargeable Battery Powered
Floor Scrubber Dryer
- 12v DC power (2x 55Ah) battery power
 - Fitted with a reliable on-board charger
 - 1600m²/h maximum working capacity
 - 400w brush motor / 400w vacuum motor
 - 450 - 540mm scrubber / squeegee width
 - 30 litre solution tank and 35 litre recovery tank
 - Brush has 150rpm speed and 18kg pressure
 - Reliable and heavy-duty mechanical traction
 - Relatively lightweight - weighs just 97kg
 - Wheel-mounted for easy movement
 - Premium Italian construction

TWO YEAR WARRANTY



MADE IN ITALY

MAINS
SIP SD1260AC
 Part No: 07980
ONLY £1,399.00
 Weekly from: £7.43*

RECHARGEABLE
SIP SD1260BAT
 Part No: 07982
ONLY £1,995.00
 Weekly from: £10.59*

TWO YEAR WARRANTY



MADE IN ITALY

MAINS
SIP SD1600AC
 Part No: 07984
ONLY £1,695.00
 Weekly from: £9.00*

RECHARGEABLE
SIP SD1600BAT
 Part No: 07986
ONLY £2,395.00
 Weekly from: £12.71*

SIP 1280/40
VALETING MACHINE

NEW
 FROM SIP

- 230v (13amp) supply
- Powerful 1200w motor (2 stage with bypass cooling)
- 65w pump
- 2200mm water lift height
- 198m³/hr air flow
- 40 litre tank capacity
- 3 litre clean water tank
- Stainless steel tank
- Wheel mounted
- Net weight 12.8kg
- Supplied with: Upholstery hand tool and flexible hose, polyester filter with support ring and sponge filter

Part No: 07928
ONLY £375.00



SIP 1230 WET & DRY
VACUUM CLEANER

NEW
 FROM SIP

- Ideal for small offices, workshops, home, garages, stores and warehouses
- 230v (13amp) supply
- Powerful 1200w motor (2 stage with bypass cooling)
- 2.2mm water lift height
- 198m³/hr air flow
- 30 litre tank capacity
- Shock proof high-density polyethylene tank
- Net weight 9.2kg
- Non-marking rubber wheels
- Supplied with: Flexible hose, 2 x extension tubes, combination brush, crevice tool, round brush, upholstery tool, squeegee floor tool, polyester filter with support ring and super fine filter bag

Part No: 07937
ONLY £175.00



**SIP TEMPEST PH540/150
HOT WATER PRESSURE WASHER**

- 230v (13amp) input supply
- Powerful 2700w (3.6hp) motor
- Electric-powered pressure washer
- 2175psi (150 bar) max. pressure
- 540 litres/hour max. water flow rate
- 8 metre durable hose w/ bent pistol lance
- Rugged brass-headed axial plunger pump
- 15L diesel boiler capacity / 4.5L detergent
- Ultra heavy-duty all-metal construction
- 90°C variable temperature thermostat
- Total Stop - power stops if not in use
- Strong one-piece bodywork cover



TWO YEAR WARRANTY



Part No: 08954

ONLY **£995.00**
Weekly from: £5.28†

**SIP TEMPEST PH600/140
HOT WATER PRESSURE WASHER**

with FREE SIP Pressure Washer Detergent 5L

- 2200w (3hp) 2,800rpm 2-pole motor
- 230v (13amp) input supply
- 2030 psi (140 bar) max. pressure
- 600 litres/hour max. water flow rate
- 15 litre diesel fuel tank for water heater
- 110°C hot water temperature
- Heavy-duty brass-head pump
- 10 metre heavy-duty hose and lance
- Unique one-piece bodywork cover
- Reliable boiler safety features
- Strong fold-down handles



TWO YEAR WARRANTY



Part No: 08941PA37

ONLY **£1,575.00**
Weekly from: £8.36†

Package Deal



2-POLE 2200W MOTOR

**SIP TEMPEST PH600/140 T4
HOT WATER PRESSURE WASHER**

with FREE SIP Pressure Washer Detergent 5L

- 230v (13amp) input supply
- 2200w (3hp) 1,400rpm 4-pole motor
- 2030 psi (140 bar) max. pressure
- 600 litres/hour max. water flow rate
- 15 litre diesel fuel tank for water heater
- 110°C hot water temperature
- Heavy-duty brass-head pump
- 10 metre heavy-duty hose and lance
- Unique one-piece bodywork cover
- Reliable boiler safety features
- Strong fold-down handles



TWO YEAR WARRANTY



4-POLE 2200W MOTOR

Package Deal



ONLY **£1,875.00**
Weekly from: £9.95†

Part No: 08956PA37

**SIP TEMPEST PH720/100
HOT WATER PRESSURE WASHER**

with FREE SIP Pressure Washer Detergent 5L

- 230v (13amp) input supply
- 3000w (4hp) 1400rpm 4-pole motor
- 1450psi (100 bar) maximum pressure
- 720 litres/hour maximum water flow rate
- 110°C boiler-fired hot water temperature
- 18L diesel boiler capacity / 3.5L detergent
- 10 metre hose w/ rugged bent pistol lance
- Ultra heavy-duty brass-head Triplex pump
- Built-in water softener and descaling tank
- Total Stop - power stops when not used
- 2 castors / 2 wheels for easy movement
- Durable ceramic pistons



TWO YEAR WARRANTY



DURABLE CERAMIC PISTONS

Package Deal



ONLY **£2,399.00**
Weekly from: £12.73†

Part No: 08958PA37

**SIP TEMPEST PH660/120HDS
HOT WATER PRESSURE WASHER**

with FREE SIP Pressure Washer Detergent 5L

- 230v supply / 2200w (3hp) 4-pole motor
- 435 - 1740psi (30 - 200 bar) variable pressure
- 330 - 660 litres/hour max. variable water flow rate
- 85 - 140°C variable water temperature range
- 18 litre diesel tank and 3.5 litre detergent tank
- Integrated water tank with anti-scale device
- Wheel-mounted for easy movement



TWO YEAR WARRANTY



BRASS HEAD TRIPLEX PUMP

Package Deal



ONLY **£2,595.00**
Weekly from: £13.77†

Part No: 08962PA37

**SIP TEMPEST PH900/200HDS
HOT WATER PRESSURE WASHER**

with FREE SIP Pressure Washer Detergent 5L

- 400v supply / 5500w (7.5hp) 4-pole motor
- 435 - 2900psi (30 - 200 bar) variable pressure
- 330 - 900 litres/hour max. variable water flow rate
- 85 - 140°C variable water temperature range
- 18 litre diesel tank and 3.5 litre detergent tank
- Integrated water tank with anti-scale device
- Wheel-mounted for easy movement



TWO YEAR WARRANTY



DURABLE CERAMIC PISTONS

Package Deal



ONLY **£2,875.00**
Weekly from: £15.26†

Part No: 08964PA37

DL240M 2 POST LIFT

4 Tonne Two Post Electro-hydraulic
Lift with 1780mm lifting height

UPLIFTING DEAL

The Dunlop DL240M Two Post Electro-hydraulic Lift

is a 4 tonne two post lift. This lift comes with electrical lock release and manual lowering valve. Two stage long rear arms and three stage short front arms are all fitted with screw adjustable (100-160mm) lifting pads. These key features help this lift to be one of the most versatile on the market within the Dunlop range.



STAR BUY



STRICTLY WHILE STOCKS LAST!

FREE HIGH LIFT PAD ADAPTORS!

4 TONNE LIFTING CAPACITY

DL240M	Technical Specification
Lifting capacity	4000kg
Lifting & lowering time 1 Phase / 3 Phase	75 seconds / 60 seconds
Minimum height	110mm - 155mm (Screw adjustable)
Maximum height	1780mm
Front minimum / maximum arm length	600mm / 1100mm (3 stage)
Rear minimum / maximum arm length	845mm / 1330mm (2 stage)
Power Requirements	1 phase or 3 phase - 16a Isolator Required
Operation	Electro-hydraulic

£2,195

Weekly from: £11.65*

*Installation is to a prepared site and excludes any builders or electrical works. Subject to free site survey.

FREE 12 MONTHS CALIBRATIONS* | 3 YEAR WARRANTY** | LASER HEADLAMP ALIGNER | AIR OPERATED PLAY DETECTOR |
TABLET INCLUDED | INSTALLED & SUPPORTED BY GEMCO SERVICE | FREE CAD DESIGN SURVEYS

**DISCUSS WITH YOUR
LOCAL BRANCH TODAY!**



BRADBURY®

PRICES STARTING FROM ONLY £23,500 (£124.73 per week)

*The 12 months calibrations offer is for 1 additional visit, which will be due 6 months after installation and commissioning. Equipment includes: Brake Tester, Lift with shaker plates, Jacking Beam, Headlamp Aligner and Emission analyser - where new machine is purchased (software and other exclusions apply). **Warranty is subject to maintenance, exclusions apply. ***Installation to a prepared site, excludes building/electrical works. #When purchased with an ATL Bay. ##Pricing based on Class IV Optl upgrade using existing brake tester.

Contact your local branch for details or call **0121 749 8801**



DUNLOP 3.5 TONNE FULL RISE SCISSOR LIFT

SUITABLE FOR
CARS & VANS

£3,895

Weekly from: £20.67†

ELECTRO-
HYDRAULIC

STAR BUY

STRICTLY WHILE
STOCKS LAST!



The DUNLOP DSL35/1 & DSL35/3 Scissor Lift is a 3.5 tonne full rise electro hydraulic scissor lift.

These lifts are suitable for cars and vans (excluding LWB). This model includes fixed ramps (run on ramp locks) which extend the platform length up to a length of 2105mm. These low profile lifts have a closed height of just 105mm and are suitable for surface mounted or recessed installation. The ultra thin structure has 2 cylinders each side that are interconnected for easy synchronisation.



H8335ME MOBILE LOW RISE SCISSOR LIFT

SUITABLE FOR
CARS & VANS

STRICTLY WHILE
STOCKS LAST!



HYDRAULIC
OPERATION

★
STAR BUY

£2,895

Weekly from: £15.37†

The Bradbury H8335ME 3.5 Tonne Mobile Low Rise Scissor Lifts are suitable for workshops with limited space. Ideal for tyre and car body shops, allowing full access to all sides of the vehicle. The low profile platforms are ideal for lifting a large range of vehicles including low skirted sport cars. Available in single phase only.

Key Features

- Safe and reliable hydraulic operation
- Low voltage control
- Automatic lubricating system - Wheel Device
- 2 Year Warranty*
- Free 1 year maintenance package included
- Lockable run on ramps
- Can also be fixed to the floor
- Set of rubber blocks included

Technical Specifications

- Lifting capacity 3500kg
- Lifting/Lowering time 40 / 20 seconds
- Platform length 1400/2025mm
- Platform height 105mm
- Overall width (excl. control box) 1960mm
- Each platform width 480mm
- Distance between platforms 900mm
- Maximum lifting height 920 - 940mm
- Weight 630kg
- Electrical Supply 1 Phase
- Motor 220v, 1.1kW
- Operation Electro-Hydraulic

*Please note the 2 Year Warranty is subject to maintenance and terms and conditions. Specifications/Images subject to change without prior notice. E&OE Images are for illustration purposes only. To validate warranty, proof of a valid maintenance contract will be required.

BRADBURY®

ATL PACKAGES



1, 2, 3, 4 Tecalemit offers you more Fantastic Deals On Tecalemit Brand Automated Test Lanes*

**CHOOSE FROM
FOUR GREAT
VALUE ADD
OFFERS**



**BRAKE TESTER PIT
FRAME AND ROLLER
COVERS F.O.C.**

Select One Of Four Value Add Options from the “1, 2, 3, 4 Tecalemit Offers You More” promotion*

*For all ATL Packages ordered in the promotional period, Tecalemit will include either of 1,2,3,4. *Not available on ATL/IV/Pit or ATL/IV/PIT/EM

1

GTR/400/W



£595

2

SF/9010/H



ONLY £1,595

3

**TIRO PACKAGE
TTC/TIRO/1 & TBM/TIRO/2500**



ONLY £1,995

4

GTR/430



ONLY £2,795

Terms & Conditions

1. For new orders only.
2. Customers name must be supplied at point of order.
3. The order for the ATL bay, and the accompanying product must be ordered at the same time.
4. Offer product can be despatched to ATL customer or another distributor customer
5. ATL bay must be despatched within 6 months of the order date
6. Additional invoice will be raised for the full value of the offer product if the ATL bay is not invoiced within 6 months of order.

2 POST LIFTS

Part No.	Lifting Capacity	Raised Height	Application	Price
SF/9010/H	3.0T	1.96m	Mechanical lift with base frame	£2,999
SF/9207	4.0T	1.8m	Hydraulic lift with base frame	£3,995



Model SF/9010/H
ONLY £2,999
 Weekly from: €15.92*

4T hydraulic lift with base frame

Model SF/9207

- Electro-hydraulic operation 4.0t 2 Post Lift
- Asymmetric lifting arms 3 stages for lifting a wide range of vehicles
- Rapid lifting time
- Structural base frame
- Electronically controlled safety latches
- Includes free high lift pads



FROM **£3,995**
 Weekly from: €21.20*

3T Mechanical Lift with Base Frame (1.96m)

- Azur 3.0t 2 Post Lift with heavy duty base frame
- Suitable for lifting most passenger cars and car derived vans
- Automatic arm locking
- 5 year warranty on self lubricating Nylatron operating and safety nuts
- Low minimum lifting pad height of just 90mm
- Foot/toe protection device

4 POST LIFTS

Part No.	Lifting Capacity	Platform Length	Application	Price
SF/9436/SR	3.5T	4.3m	Servicing & Class IV MOT*	£5,995
SF/9084	4.0T	5.0m	Service Lift	£6,295

* Requires radius turning plates for M.O.T.

3.5T Service Lift

- Maximum Load: 3500kg
- Raised Platform Height: 1700mm
- Lifting Time: 50 sec
- Lowering Time: 45 sec
- Power Supply: 3ph 400v 50hz
- Fused Isolator Rating: 15amp
- Motor: 2.2kw
- Net Weight: 940kg
- Minimum Height: 120mm

ONLY **£5,995**
 Weekly from: €31.82*

Model SF/9436/SR



single phase options available at extra cost.

single phase options available at extra cost.



ONLY **£6,295**
 Weekly from: €33.41*

Model SF/9084

4T Service Lift

- Lifting Capacity: 4000kg
- Net Weight: 900kg
- Lifting/Lowering Time (3ph): 35 sec
- Lifting Height: 1830mm
- Minimum Height: 165mm
- Motor Supply: 3kw
- Power Supply (3ph): 400v 50hz
- Fused Isolator Rating: 20amp

SCISSOR LIFTS

Part No.	Lifting Capacity	Lifting Height	Application	Price
SF/8030 SURFACE	3.0t	1.87m	Short platform, low profile	£5,295
SF/8994	4.0t	1.9m	Short platform, recessed	£5,750

* Requires radius turning plates for M.O.T.

4T In-ground Scissor Lift

- Raised height: 1900mm
- Motor supply: 400 3kW - 3Ph 50Hz
- Maximum load: 4000kg
- Lifting/Lowering time: 35 secs
- Net weight: 700kg
- Operation: Electro-hydraulic
- Shipping specifications: 160 x 65 x 130cm

ONLY **£5,750**
 Weekly from: €30.52*

Model SF/8994



3T Scissor Lift

- Operation: Electro-hydraulic
- Capacity: 3000kg
- Weight: 750-850kg
- Lifting/lowering time: 60/55 secs
- Lifting height: 1870mm
- Motor: 2.2kW 230-400V / 50Hz - 3ph

ONLY **£5,295**
 Weekly from: €28.10*

Model SF/8030 SURFACE

TYRE & WHEEL PACKAGES

TIRO Package Deal: Automatic Tyre Changer + Electronic Wheel Balancer

Tiro Automatic Tyre Changer

Tiro Wheel Balancer

USES THE VERY LATEST BALANCING TECHNOLOGY

- TBM/Tiro/2500 Wheel Balancer**
- Electronic motorised wheel balancer
 - Suitable for most car and light van wheels weighing up to 65kg
 - Easy data entry
 - LED display
 - 1 steel and 4 alloy type balancing programmes
 - Includes a foot brake
 - Supplied with 4 mounting cones



- TTC/Tiro/1 Automatic Tyre Changer**
- Entry level automatic tyre changer
 - Suitable for car wheels up to 23" diameter
 - Pneumatically controlled tilting column
 - Complete with assistant arm and roller system
 - Pneumatic bead breaker
 - 2 directional turntable

A.
Model
TBM/TIRO/2500

A.
Model
TTC/TIRO/1/RAL5002

ONLY
£3,295

Weekly from: £17.49*

Polaris Automatic Tyre Changer



B.
Model
TTC/300/TH

PRO PLUS PACKAGE TTC/300/TH + TBM/200

+ HAW/140400091
Truck Cone & Spacer FOC FREE

- TBM/200 ELAN Automatic Wheel Balancer**
- Automatic wheel balancer with data entry
 - Multi operator program
 - Wheel width measurement gauge
 - Self diagnosis and user calibration for simple maintenance
 - 5 ALU programs, plus static and standard programs
 - Foot brake for locking the wheel
 - Split weight system
 - Double LED display

- TTC/300/TH Polaris Automatic Tyre Changer**
- Automatic tyre changer
 - Extra height column to accommodate wheels up to 15" wide
 - Chassis allows increased overall wheel diameter of 46"
 - External clamping up to 28"
 - Re-designed double acting bead breaker blade for working on wider/larger wheels
 - Improved roller design for run flat tyres
 - Tecnoarm helper system

PRO PLUS PACKAGE
ONLY
£5,999

Weekly £31.84*

USES THE VERY LATEST BALANCING TECHNOLOGY



B.
Model
TBM/200

Elan Automatic Wheel Balancer

GTR/400/W

Compact easy to use high precision 4 wheel laser alignment system.

GTR/400W

- Highly accurate and easy to use
- Suitable for car wheel rim sizes up to 23"
- Compact wall mounted storage of equipment
- On-rack recharging of lasers
- Includes pedal applicator and steering wheel clamp
- Measures front & rear toe, total toe, set-back and rear axle thrust line



GTR/400W FROM ONLY

£2,179

Weekly from: £11.57†



CALL FOR A DEMO

GTR/430

4 Wheel Laser Alignment with Vehicle Database and Live Data

GTR/430

- Developed by Tecalemit to provide rapid measurement of key vehicle geometry angles
- Compact and easy to use high precision 4 wheel laser aligner
- Autodata database with red/green display of results when in/out of parameter
- Includes a brake pedal depressor, steering wheel clamp and radius plates
- Zigbee wireless PC interface which allows for measurement results to be printed and archived on to the supplied PC
- 2x built-in camber caster gauges
- Stylish new cabinet on wheels houses the PC and printer



FANTASTIC DEAL!!



GTR/430 FROM ONLY

£4,795

Weekly from: £25.45†

Optional camber caster (LA/CTD) available

User install, training DVD provided

£450

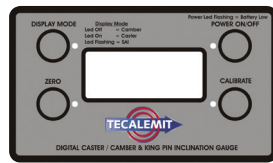

GTR/3000

Full 4 Wheel Alignment Wireless 8CCD Camera System

GTR/3000

- Quick & easy measurements in a few minutes
- 8 CCD electronic measuring heads
- Bluetooth cable free communication
- PC controlled/windows operating system
- Precision measurement of angles
- Haweka Pro-clamp wheel mounting system, no run out compensation needed
- Extensive vehicle database
- Colour before/after printout
- Camera tilt facility overcomes low spoilers
- The unit has freeze frame facility to use on 2 Post Lifts

Model GTR/3000

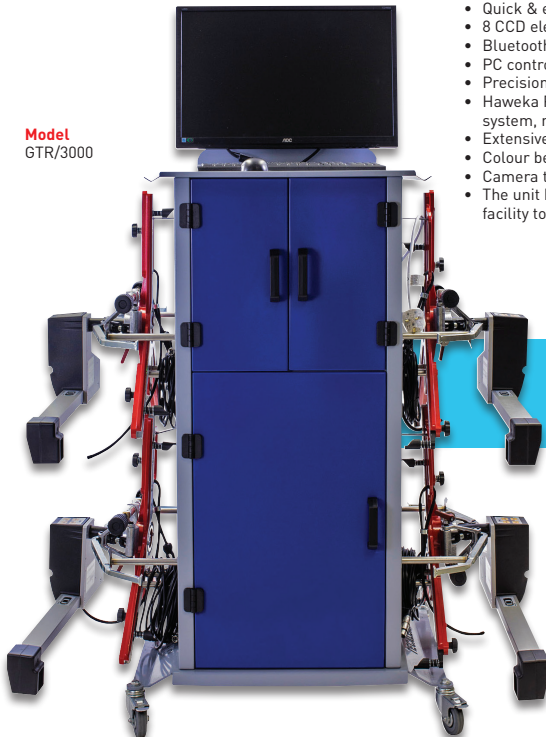

CALL FOR A DEMO

GTR/3000 FROM ONLY

£7,995

Weekly from: £42.44†

GTR/8400

New 3D Computerised 4 Camera Wheel Alignment System

GTR/8400

- 4 HD digital video cameras enable rapid target capture at any ramp height eliminating the need for a movable boom
- Utilising 4 cameras enables cameras to be positioned closer to the ramp than is possible with 2 camera systems
- The 4 wide angle cameras provide up to twice the range of working heights compared with 2 camera systems
- Unique "Machine Vision" software provides accurate measurements without the need to calibrate targets
- Integrated database incorporates alignment specifications, adjustment diagrams and 3D animated instruction videos

- Self centering wheel adapters accommodate wheel sizes 12" - 24"
- Integrated storage for adapters and targets on the cabinet
- Cabinet comes with high specification fast PC, extra wide 27" monitor, printer, and unique wireless remote control



GTR/8400 FROM ONLY

£10,495

Weekly from: £55.70†

FREE GTR400/W When you purchase a GTR/8400 Wheel Alignment System



NEW EAE 5 year 2+2 warranty: the equipment will be covered for a 5 year structure 2 year hydraulic and 2 year electrical parts*

EE-612FE 2.5T SINGLE POST LIFT



5 YEAR WARRANTY +2+2

ELECTRICAL SAFETY LOCK RELEASE SYSTEM

ONLY £3,595
Weekly from: £19.08*

Main Features

- CE certified by SGS UK
- Screw Action Height Adjustable Pads with clearance height < 110mm
- Door protection pads
- ABS Control Box
- Automatic Engaging Arm Locks
- Anti-Surge Hydraulic Valve
- Reserved Hydraulic Connection for Optional Manual Operated Pump

Model No.	EE-612FE
Lifting Capacity	2,500KG
Max Lifting Height	1,800mm
Min Height	120mm

EE-612E 2.5T MOBILE SINGLE POST LIFT



5 YEAR WARRANTY +2+2

ANTI-SURGE HYDRAULIC VALVE

ONLY £3,695
Weekly from: £19.61*

Main Features

- CE certified by SGS UK
- Mobile Positioning based on Pallet Jack System
- Electrical Safety Lock System
- Screw Action Height Adjustable Pads with clearance height < 110mm
- Door Protection Pads
- Hydraulic System with Fixed Pressure
- ABS Control Box

Model No.	EE-612E
Lifting Capacity	2,500KG
Max Lifting Height	1,800mm
Min Height	130mm

EE-6255E 5T TWO POST LIFT

5,000KG Floor Plate Lift, Electrical Release



5 YEAR WARRANTY +2+2

RUBBER DOOR PROTECTION PADS

ONLY £3,895
Weekly from: £20.67*

Main Features

- CE certified by SGS UK
- Base Plate Design for Low Ceiling Application
- Electrical Safety Lock Release System
- Screw Action Height Adjustable Pads with clearance height < 100mm
- Automatic Engaging Arm Locks
- ABS Control Box
- Anti-Surge Hydraulic Valve
- Hydraulic System with Fixed Pressure

Model No.	EE-6255E
Lifting Capacity	5,000KG
Max Lifting Height	1,900mm
Min Height	100mm

EE-6215E 5T TWO POST LIFT

5,000KG Clear Floor Lift, Electrical Release

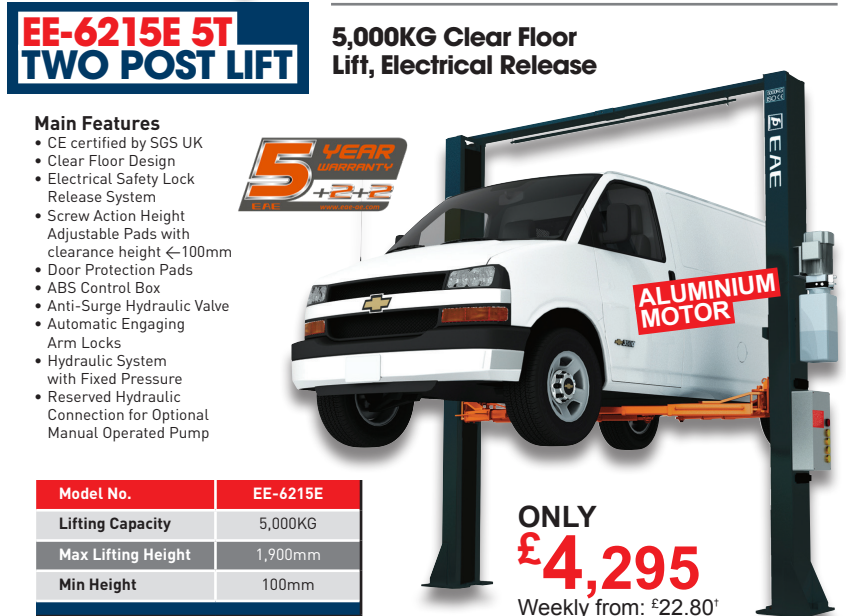

5 YEAR WARRANTY +2+2

ALUMINIUM MOTOR

ONLY £4,295
Weekly from: £22.80*

Main Features

- CE certified by SGS UK
- Clear Floor Design
- Electrical Safety Lock Release System
- Screw Action Height Adjustable Pads with clearance height < 100mm
- Door Protection Pads
- ABS Control Box
- Anti-Surge Hydraulic Valve
- Automatic Engaging Arm Locks
- Hydraulic System with Fixed Pressure
- Reserved Hydraulic Connection for Optional Manual Operated Pump

Model No.	EE-6215E
Lifting Capacity	5,000KG
Max Lifting Height	1,900mm
Min Height	100mm

EE-6501 3T FULL-RISE SCISSOR LIFT



5 YEAR WARRANTY +2+2

Main Features

- CE certified by SGS UK
- Surface Mount Design (110mm)
- Pneumatic Safety Lock Release System
- Drive-on Ramp Lock into Position as Platform Extension
- Self-Lubricated Bushings and Bearings
- ABS Control Box with Metal Cabinet
- Anti-Surge Hydraulic Valve
- Hydraulic System with Fixed Pressure
- Four Hydraulic RAM Design

Model No.	EE-6501
Lifting Capacity	3,000KG
Max Lifting Height	1,850mm
Min Height	110mm

ONLY £3,895
Weekly from: £20.67*

EE-MR30 3T MID-RISE SCISSOR LIFT



5 YEAR WARRANTY +2+2

MOBILE KIT INCLUDED

CALL TO GET YOURS NOW!!

ONLY £2,395
Weekly from: £12.71*

Main Features

- CE certified by SGS UK
- Mobile or Fixed Mount Design
- Mobile Kit included
- Diamond Plate Surface
- Self-Lubricated Bushings and Bearings
- ABS Control Box
- Anti-Surge Hydraulic Valve
- Hydraulic System with Fixed Pressure
- Includes delivery and standard installation

*Delivery restrictions apply on this item - please check with our Garage Equipment Department before ordering.

Model No.	EE-MR30
Lifting Capacity	3,000KG
Max Lifting Height	1,000mm
Min Height	105mm

NEW EAE 5 year 2+2 warranty: the equipment will be covered for a 5 year structure 2 year hydraulic and 2 year electrical parts*



**EE-6254E 4T
TWO POST LIFT**

**Base Plate Lift
with Electrical
Release**

Main Features

- CE certified by SGS UK
- Base Plate Design for Low Ceiling Application
- Electrical Safety Lock Release System
- ABS Control Box
- Anti-Surge Hydraulic Valve
- Automatic Engaging Arm Locks
- Hydraulic system with fixed pressure
- Screw Action Height Adjustable Pads with clearance height ←100mm

**FANTASTIC
TWO POST
LIFT!!**

**CALL TO
GET YOURS
NOW!!**

**ONLY
£2,495**
Weekly from: £13.24†

Model No.	EE-6254E
Lifting Capacity	4,000KG
Max Lifting Height	1,900mm
Min Height	100mm

**DELIVERED &
FULLY INSTALLED**

**TYRE CHANGER &
WHEEL BALANCER
PACKAGE DEAL**

**CALL FOR
MORE INFO**

**EE-4880ID
Tyre Changer**

- Pneumatically operated tilting column
- Simultaneous pneumatic horizontal and vertical arm locking
- Pneumatic bead breaker
- Durable and convenience operation
- Tilting column and pneumatic locking system
- Bigger bead breaker cylinder ø200, more powerful
- CE certified

**EE-3096AV2
Wheel Balancer**

- CE certified
- For passenger car, motorcycle and light commercial vehicle wheels
- Hand-operated distance and wheel diameter input
- Various balancing modes
- Self-calibration and diagnosis
- Plastic safe-guard works as the START and STOP
- Optional centreless wheel adapter, motorcycle adaptor and truck and van cones

**Package Deal
£2,495**
Weekly from: £13.24†



EE-4880ID Tyre Changer	EE-3096AV2 Wheel Balancer
Rim material: Steel, AL., Alloy	Max. wheel weight 65KG
Max. wheel diameter: 45"	Motor Power: 0.2kw
Max. wheel width: 14"	Rim diameter: 10"-24"
Outer clamp: 12"-23"	Rim width: 1.5"-20"
Motorcycle clamp: 12"-26"	Balancing speed: 220RPM
Power supply: 110V/220V/380V	Balancing accuracy: 1g
Motor power: 0.75KW/1.1KW	Power supply: 220V
Air supply: 8-10Bar	Noise level: <70dB
Noise level: <70dB	-

MOT EQUIPMENT

Upgrade your existing equipment to conform with OPTL Test Lane standards (One person Test Lane)

Carry out MOT tests, without using an assistant, by upgrading your MOT lift (to a 4-Post or Scissor Lift) but keeping your existing Brake Tester, Headlamp Beam Tester and Emission Equipment.

- Your OPTL lift comes complete with flush fitted Play Detectors and Turn Plates, Jacking Beam (manually operated), Brake Pedal Depressor and Mirror Kit
- Many lifts can be upgraded with no additional groundworks
- Many lifts can be supplied with rear slip plates and wheel alignment equipment to provide additional revenue

Liftmaster

LIFTS CAN BE UPGRADED

SPECIAL OFFER!!



Upgrade price for Class IV from £9,395
Upgrade price for Class VII from £10,995



Upgrade price for Class IV from £12,695
Upgrade price for Class VII from £14,295

XPR9 SERIES

4 tonne 2 Post Electro/Hydraulic Lifts

Liftmaster

- 4.0 Tonne Lifting Capacity
- Standard or wide configurations
- 3 year comprehensive and 5 year structural warranty

- Screw Pad Adapter as standard
- 4-piece 63mm stackable set comes as standard
- Power unit on either side

BEST SELLER!



Single phase electric at no extra cost

XPR9TS
£3,295

Weekly from: £17.49*

(Picture shows lift with 125mm extension piece which are available to order at an extra cost)

XPR12 SERIES

5.4 Tonne 2 Post Electro/Hydraulic Lift

- 5.4 Tonne Lifting Capacity
- 3 year comprehensive and 5 year structural warranty
- Triple reach telescopic front and rear arms
- 16-piece 4x4 Van adapter set comes as standard
- Power unit on either side

XPR12FDL
£4,999

Weekly from: £26.53*

XPR12FDL-LWB Long Wheel Base
£5,495

Weekly from: £29.17*



Liftmaster

HD9 SERIES

4 Tonne 4 Post Electro/Hydraulic Lifts (Overall Width 2800mm)

- 4.0 Tonne Lifting Capacity
- 4166mm Platform length
- Low profile Lift Platforms 114mm
- Drive through ramps available
- 2 years comprehensive and 5 year structural warranty
- Pneumatic push button mechanical safety release



HD9 SERIES
£3,595

Weekly from: £19.08*

HD9ST
£3,595

Narrow width (2534mm)

Weekly from: £19.08*

HD9XW
£3,950

Long platforms (4775mm)

Weekly from: £20.97*

HDS14 SERIES

6.35 Tonne 4 Post Electro/Hydraulic Lift



HDS14 Series

- 6.35 Tonne Lifting Capacity
- 5054mm Platform length
- Low profile Lift Platforms 192mm
- Drive through ramps available
- 2 Year Comprehensive and 5 Year structural warranty
- Pneumatic push button mechanical safety release

HDS14
£4,995

5054mm Platform Length

Weekly from: £26.51*

HDS14LSX Wheel Alignment Lift
£6,395

5054mm Platform Length

Weekly from: £33.94*

HDS14X Long Platforms
£5,995

5816mm Platform Length

Weekly from: £31.82*

HDS14LSX IS A WHEEL ALIGNMENT LIFT COMPLETE WITH REAR SLIP PLATES

PACKAGE DEAL

TWO MACHINES FOR A FANTASTIC PRICE!!



R76ATRF Tyre Changer

- 44" Maximum Tyre Diameter
- Leverless Tyre Demount Head
- 4" to 19" Turntable Tyre Width Capacity
- Power Assist Arm for Awkward & Run Flat Tyres
- Variable/Dual Speed Turntable
- 9" to 28" External Clamping
- 30" Turntable

2 YEARS WARRANTY

SPECIAL OFFER!!



DST2420 Wheel Balancer

- Weight Optimisation
- Automatic Braking
- Hidden Spoke Mode
- 22" Maximum Wheel Width
- 30" Maximum Wheel Diameter
- Self-Calibration
- Includes Mounting Cone Package
- Digital Sensor Technology Allows +/- 0.5g Accuracy

PACKAGE PRICE £4,595

Weekly from: £24.39*

HPJ2.0DE JACKING BEAM

£690 when purchased with lift

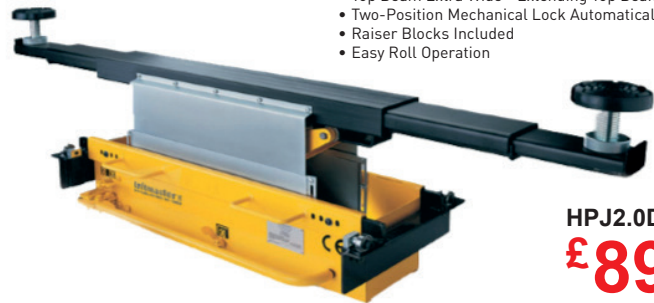

HPJ2.0DE
£895

- 2.0 Tonne Manual Jacking Beam
- Top Beam Extra Wide - Extending Top Beam to 1700 mm
- Two-Position Mechanical Lock Automatically Engages
- Raiser Blocks Included
- Easy Roll Operation

BENDPAK RJ-7 JACKING BEAM

£625 when purchased with lift

- 3 Tonne
- Hydraulic
- Air Assisted
- Telescopic Arms
- Frame Contact Pads

BendPak
PROVIDING AUTOMOTIVE SERVICE SOLUTIONS

RJ-7
£1,295

Weekly from: £6.87*



WIRELESS ATL BAY

DUAL REVENUE ATL

Dual Revenue 5.2m or 5.7m Lift with Rear Slip Plates as standard, to allow wheel alignment on the same lift, creating better return for your investment.

- Wireless torch and shaker plate control
- Unique cable and pulley alignment
- Hose and wiring tidier
- geogas 5000 emissions analyser with industry leading water control system
- Wireless geogas 5000 includes EOBD RPM and oil temperature trigger device for diesel testing

Industry-leading, DVSA approved automated test lane system



CALL FOR MORE INFO

GEOGAS 5000

The geogas 5000 gives you everything you need in today's modern workshop for petrol and diesel emissions testing.

- Modern and compact mobile workstation
- Easy to use, icon-driven operations
- Large 27" LCD monitor
- Wireless smoke head
- Category A & B diesel smoke emissions testing
- Wireless RPM and oil temperature measurement device with ripple/battery measurement function
- New wireless OBD RPM and oil temperature trigger device for diesel testing
- NOX upgradeable

**UP TO £1,600
TRADE IN ON
SELECTED
MACHINES**

**DEVELOPED WITH TODAY'S
MODERN WORKSHOP IN MIND.**

GEOGAS 5000
£6,495

Weekly from: £34.47*



WHEEL ALIGNMENT

GEOLINER 610

Features

- Tilting camera system eliminates the need for fixed position for carrying out alignment checks and positions the camera at a touch of a button
- Clamping range 11"-22" with interchangeable grippers for different wheel types
- Vehicle Orientation Directional Indicator guides the technician when unable to see the screen
- Pro 32 software with graphical user interface including comprehensive vehicle database



Part No: EEWA721C

EVERYTHING MOUNTED ON THE SUPPORT POST & PRO 32 SOFTWARE

CALL FOR A DEMO

GEOLINER 610 FROM

£6,995

Weekly from: £37.13*

WHEEL ALIGNMENT

GEOLINER 650

Features

- 3D imaging technology
- Comprehensive manufacturers' specifications - 25+ years
- Take a full four wheel alignment reading in minutes



NEW

3D ALIGNER WITH LIFTABLE 2 CAMERA BEAM, TFT FLAT PANEL 22" SCREEN & PRO 42 SOFTWARE

FREE 1 DAY IMI TRAINING

CALL FOR A DEMO

GEOLINER 650 FROM

£8,995

Weekly from: £47.74*

HOFMANN LIFTS

Mid Rise Lift

Features

- Portable kit as standard
- Pneumatic safety locks
- 4 rubber lifting blocks
- Locking platform extension for lifting longer vehicles
- Single phase operation

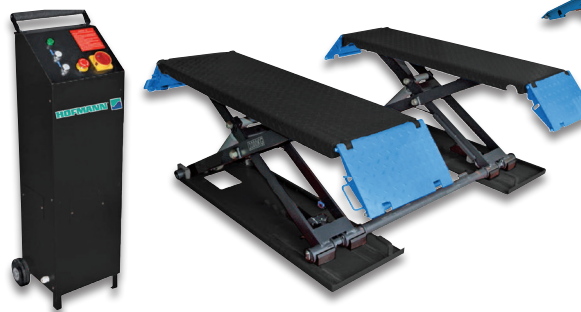

4T/5T MOT/ATL/ALIGNMENT SCISSOR LIFT ALSO AVAILABLE

MID-RISE STARTING FROM

£3,150

Weekly from: £16.72*

HOFSL 3000 Double Scissor

Features

- Short sill lift designed for surface-mounted installation
- 4 hydraulic ram system for added safety and stability between platforms
- Pneumatic safety locks
- Lifting capacity 3000KG
- 4 rubber lifting blocks



Lift your business to new heights

FULL-RISE 1 PHASE

£5,995

Weekly from: £31.82*

FULL-RISE 3 PHASE

£5,499

Weekly from: £29.19*

MSE 5500

5.5 tonne 2 post electro-mechanical clear floor lift

Features

- Without base frame (clear floor)
- Electro-mechanical drive via two synchronised motors
- Symmetrical design with three stage arms, allowing access even to the original pickup points of VW Crafter and Mercedes Sprinter
- Automatic arm locks
- Carriage and arms are designed to guarantee optimum door clearance when the car is placed on the lift
- Automatic lubrication system
- Extremely rugged design
- **Standard accessories:**
Set of four standard lifting pads

STARTING FROM

£9,295

Weekly from: £49.34*

PACKAGE 1

DELIVERED & INSTALLED

Features

- Pneumatic tilting column
- Total clamping range 10 – 20 inch
- Table has 2 cylinders for improved gripping of the rim
- Side bead breaking with adjustable inclination
- Easymount assist arm
 - Drop centre pressing tool
 - Rim centre pushing tool
- Steel head with plastic inserts

MONTY 3300 20 Smart

*Image shown with optional Plus Kit fitted



Features

- Clear and intuitive LED display
- 2D SAPE to measure wheel offset and wheel diameter in one process
- VPI measuring system for high accuracy and repeatability
- Split weight mode – Hide weights behind wheel spokes for more appealing cosmetic finish
- Tyre matching mode – optimise tyre to rim so using less weights
- Small footprint
- Measuring speed 100rpm
- Wheel guard

GEODYNA 7100 Digital Wheel Balancer



NEW PACKAGE

£4,995

Weekly from: £26.51*

PACKAGE 2

DELIVERED & INSTALLED

Features

- Double-acting bead-breaker cylinder
- Self-centering four-jaw turntable
- Mounting tool with plastic protection
- Quick-inflating valve
- Outer clamping range up to 24 inches
- Pneumatic tilt-back post, pneumatically locked in working position and pneumatically tilted forwards/backwards
- Pedal controlled inflation
- Tool box with integrated precision pressure gauge
- Bead breaker with three length positions
- Bead breaker inclination adjustable

MONTY 3300 24 Smartspeed

Image shown with optional Plus Kit fitted



Features

- 2D SAPE to measure wheel offset and wheel diameter in one process
- VPI measuring system for high accuracy and repeatability
- Intuitive control panel and video display
- EasyALU to automatically recognise the weight mode – ALU-P or steel
- Split weight mode – Hide weights behind wheel spokes for more appealing cosmetic finish
- Tyre matching mode – optimise to rim so using less weights
- Small footprint
- Measuring speed 200rpm
- Wheel guard

GEODYNA 7200 Video Wheel Balancer



NEW PACKAGE

£5,699

Weekly from: £30.25*

HURRY WHILE STOCKS LAST!!

PACKAGE 3

DELIVERED & INSTALLED

Features

- Double-acting bead breaker cylinder
- 4 self-centering turntable jaws
- Quick-inflating valve
- Outer clamping range up to 24 inches
- Pneumatic tilt back post, pneumatically locked in working position
- Re-designed easymount PRO suited for handling run-flat tyre systems (additional optional adapters required /for PAX and CSR)
- Pedal controlled inflation
- Tool box with integrated precision pressure gauge
- Bead-breaker blade supported in three joints and adjustable in five positions
- German Tyre Industry Association certification
- Plus Kit as standard
- Ergonomic low and wide chassis

MONTY 3300 Racing SmartSpeed Plus

HURRY WHILE STOCKS LAST!!



Features

- 2D SAPE and Smart Sonar for faster and fully automatic input of all the key wheel measurements
- Wi-Fi for sharing data with computers for display and printing (requires customer's own broadband connection)
- 10 inch touchscreen monitor with Gold level software
- Split weight mode – Hide weights behind wheel spokes for more appealing cosmetic finish
- EasyWeight pinpoint laser indicator for adhesive weight placement
- EasyALU to automatically recognise the weight mode – ALU-P or steel
- QuickBal – reduced measurement 4.5 seconds (15" rim)
- Tyre matching mode – optimise tyre to rim so using less weights
- VPI measuring system for high accuracy and repeatability
- Measuring speed 200rpm
- Wheel guard

NEW GEODYNA 7340L Video Wheel Balancer with Sonar + Laser



NEW PACKAGE
£7,495

Weekly from: £39.78*



Monty 3300 Racing SmartSpeed Plus + Geodyna 7340L

FANTASTIC PACKAGE!!

THE COMPLETE WHEEL ALIGNMENT PACKAGE



geoliner 650 XD wheel alignment system

Features

- Moveable camera beam
- Ultra-high resolution cameras
- Lightweight XD targets
- Pro 42 software

geoliner 650 XD wheel alignment system

Four-post wheel alignment lift

Features

- Built-in rear slip plates
- Premium turnplates
- In-fill paddle kit
- FREE jacking beam included



PACKAGE FROM
£17,995

Weekly from: £95.51*

Four-post wheel alignment lift

Rowley Spray Booths

Rowley Spraybooths have over forty years experience in the manufacture, installation and maintenance of Spraybooth ovens in the finishing / refinishing industry. All Rowley Spraybooth oven equipment is manufactured in the UK at their manufacturing facility located in Cannock, Staffordshire.



AERO-ECO SPRAYBOOTH OVEN

Featuring dynamic air moving plant and an energy efficient control system the AERO-ECO Spraybooth oven is designed to deliver ultimate economy with ultra-low running costs. The AERO-ECO Spraybooth has a spacious cabin constructed from modular single 'skin' (or double 'skin') bright galvanised steel panels with good lighting and wide access component doors. Utilizing rear chest extraction and compact air handling plant the AERO-ECO Spraybooth provides the perfect painting environment for any type of work. The tunnel airflow design provides excellent paint over spray mist clearance during spraying operations and uniformity of air temperatures on spray and bake modes.

FROM ONLY
£12,999

Weekly from: £68.99*



AERO-MIDI SPRAYBOOTH OVEN

The spacious AERO-MIDI cabin is constructed using modular double 'skin' insulated panels to give good thermal retention, rigidity and sound dampening. Utilizing a rear chest extraction expensive underground extraction pit works are not required and this allows the installation to be easily relocated. This tunnel airflow design provides excellent paint over spray mist clearance during spraying operations and uniformity of air temperatures on spray and bake modes.

IDEALLY SUITED FOR USE WITH
WATER BASED PAINT SYSTEMS

FROM ONLY
£15,495

Weekly from: £82.24*



AERO-MAXI SPRAYBOOTH OVEN

The AERO-MAXI Spraybooth oven range is a high specification Spraybooth oven that provides the highest quality environment for all types of paint application and low bake curing operations. The larger AERO-MAXI Spraybooth oven cabin is constructed using modular double 'skin' fully insulated panels to give good thermal retention, rigidity and sound dampening. Utilizing a rear chest extraction expensive underground extraction pit works are not required and this allows the installation to be easily relocated. This tunnel airflow design provides excellent paint over spray mist clearance during spraying operations and uniformity of air temperatures on spray and bake modes.

IDEALLY SUITED FOR USE WITH
WATER BASED PAINT SYSTEMS

FROM ONLY
£18,995

Weekly from: £96.82*



AERO-INDUSTRIAL/COMMERCIAL SPRAYBOOTH OVEN

The Industrial and Commercial Spraybooth oven range can be designed to meet customer's specific requirements for Spraybooth ovens. The flexible modular design allows the cabin size and air flow requirements to be made to suit the products being painted.

**CALL NOW
FOR A QUOTE**

MIDRISE SCISSOR LIFT

**PORTABLE & COMPACT
TO FIT IN ANY WORKSHOP**

- Lifts most vehicles, including SUV's up to 3 tonnes
- Suitable to use indoors and outdoors
- Twin hydraulic cylinders avoids bagging
- High performance oil-submerged power unit

- Attractive galvanised checker plate platform ensures maximum protection against corrosion
- Extended platform for long-wheel base vehicles
- Quick and easy installation



**3
TONNE**

Supplied with 4 Polymer Pads



Manufactured
in Germany



**3
YEAR
WARRANTY**

SCISSOR LIFT ONLY
£2,995
Weekly from: £15.90*

Part No. CML3000

2 POST SERVICE LIFT

This quality 2-post service lift is electro-mechanically operated, suitable for servicing and repairing different sized vehicles up to 3 tonnes.

- Lifts cars, vans and light trucks up to 3 tonnes
- Leaves the underbody open to ensure quick service repairs e.g. brakes and suspension
- Precision height adjustment
- 5 years warranty on spindle and spindle nut
- Resistant Poly-V belt
- Two synchronised motors integrated into columns
- No base frame for a low lifting point
- Manufactured to the highest standards with complete quality control at all stages

**3
TONNE**

**3
YEAR
WARRANTY**

Asymmetric Arms
Offering clear access
to the vehicle interior



2 POST LIFT ONLY
£3,250
Weekly from: £17.25*

Part No. C2L3000E

Manufactured
in Germany



**PROTECTED BY
GALVANISED COVERS**

Handy helpers for everyday workshop tasks



AUTODIAGNOS CHECK

- Plug & Play for maximum efficiency
- User-friendly icon-based navigation
- OE data
- Covers all major car & van manufacturers
- Quick boot-up time
- One year of FREE software updates
- Lifetime warranty (when subscription is upheld)

FROM **£595.00**
~~Normally £1,200~~

LOWER PRICE



Plug & Select



Plug the tool into the vehicle and all of the essential service applications are ready to select from startup.

Plug & Identify



Select the car manufacturer and the tool will automatically identify the model, year and associated control units for maximum efficiency and accuracy.

Plug & Fix



The tool will guide you straight through the service process, avoiding any complicated options or misleading suggestions for maximum efficiency. A suitable tool for any workshop without any diagnostic experience required.

TPMS - THE FASTEST GROWING BUSINESS OPPORTUNITY FOR GARAGES

- Compact TPMS testing and programming devices
- Cover a wide range of vehicle manufacturers
- Display battery status, temperature & tyre pressure of each sensor
- Suitable for all OE sensors and most universal sensors worldwide
- Program replacement sensors quickly
- Relearn new TPMS sensor ID to the vehicle's ECU
- Printer & docking station (TPMS Pro Print: add £100)
- FREE software updates (1 Year for Pro, 2 Years for Go)

NEW

#1 SELLING TPMS TOOL WORLDWIDE



TPMS Go
£399.00



TPMS PRO
£749.00

TPMS Pro Print: Add £100.00

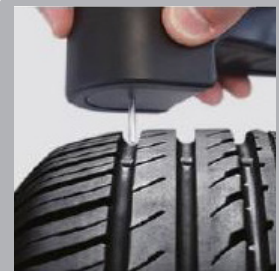

TYRE TREAD GAUGE ONLY
£267.00

NEW

Optional with TPMS Pro

CALL FOR MORE INFO



Functionality	Go	Pro
Easy Make-Model-Year look-up	✓	✓
Worldwide vehicle coverage, always up-to-date	✓	✓
Activates all OEM sensors, displays all sensor data	✓	✓
Programs universal sensors (configurable, hybrid, ID copy etc)	✓	✓
Provides TPMS relearn procedures in +22 languages (incl. indirect/direct)	✓	✓
Indicates OE sensor and service kit part numbers	✓	✓
Programs sensors from historical data	✗	✓
Programs sensors by wheel set	✗	✓
Includes OBDII routines to reset the ECU in <2 mins	✗	✓
Pictures indicate OBDII location in car	✗	✓
Displays TPMS data for up to 7 tyres in one screen	✗	✓
Retrieves and decodes TPMS DTC information	✗	✓
Stores up to 65k vehicle job data in one place	✗	✓
Hardware	Go	Pro
Robust design (drop tested up to 3 feet, liquid resistant)	✓	✓
Display	2.8" monochrome	4.3" LCD screen
Internal lithium-ion battery	✓	✓
SD card storage	✗	✓
Wi-Fi capable for PC synchronization	✗	✓
OBDII module	✗	✓
Accessories	Go	Pro
Tyre tread depth reader	✗	Optional
IR thermal printer	✗	Optional
Docking station	✗	Optional

MOT BAYS/ ATL PACKAGES

A full Crypton ATL Package includes a lift or pit, emissions tester, brake tester, turntables, wheel play detectors (wireless with scissor lifts), headlamp aligner, jacking beam & 3 years warranty.

WATCH
HERE →



Features

- Fully approved equipment by DVSA
- NEW!** 6.5m 4-Post lift for long-wheel base vehicles, including motorhomes
- Attractive quality checker plate surface guarantees maximum protection against corrosion (lifts only)
- Project manager from conception to completion with site survey and CAD drawing service
- OPTL options available

CALL FOR PRICING



**BE PROUD, BE PROFESSIONAL,
BRING IN YOUR CUSTOMERS!
FREE MOT BANNER!**

All Crypton ATL Packages include a Crypton Combi Emissions Analyser (see below)

3 YEARS PARTS & LABOUR WARRANTY



Optional: brake tester adapter kits for motorbikes and 4x4s. *Ask for details.*

COMBINED EMISSIONS TESTER

THIS GUY WILL SURVIVE THE WINTER...BUT WILL YOUR EMISSIONS TESTER?

Old emissions testers are more likely to break down during the winter months due to condensation that is created by the hot emissions.

Buy the CCP800 series by Crypton to avoid any downtime

- Includes the latest Euro 6 & petrol updates
- Tests vehicle classes 4, 5 & 7
- Operates the brake tester (when purchased)
- Available as cabled or wireless
- NEXT DAY DELIVERY** (ordered before 2pm) - excl. Scotland, Highlands & Islands

UPGRADE! 5YR EXTENDED CARE

- Parts
- Labour
- Calibrations
- M.O.T. (petrol) updates
- Routine consumables (at time of calibration)

All costs are covered for a hassle free service



INCLUDED

Oil temperature probe

Automatic calibration on smoke meter

Gas analyser accurate to OIML Class 0

Delivery and on-site commissioning

Large 23" coloured screen

Robust mobile cabinet

3 year warranty



Euro 6
Compliant

CABLED
£4,495

Weekly from: £23.86*

BLUETOOTH
£5,295

Weekly from: £28.10*

EXT. CARE
£3,295

Weekly from: £17.49*

WINTER WARMER
FREE Continental branded bodywarmer

FREE



Crypton - A brand of the Continental Corporation

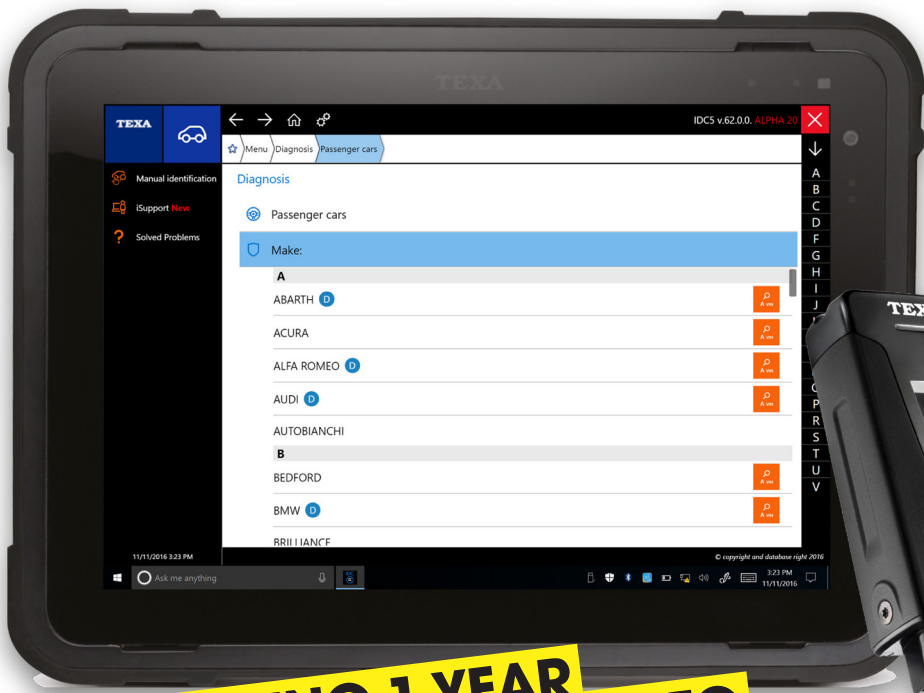

Part No:
UKD2491



**INCLUDING 1 YEAR
CAR TEXPACK, TEX@INFO
& 2 YEARS WARRANTY**

Car/LCV Nano S VCI
£4,395
Weekly from: £23.33*



TEQA's Multi-Functional Diagnostic Tool

The **AXONE Nemo** is the UK's best selling TEQA diagnostic tool that covers over 60 car makes. Using the Axone Nemo in conjunction with the Navigator Nano S, this enables mechanics to complete all diagnostic tests efficiently. The **AXONE Nemo** is packed with advanced technology and features including:

- An Ultra-wide 12 inch Screen
- Gorilla Glass
- A Quad Core Processor
- Wi-Fi and Bluetooth Connectivity
- 2 x 5 Megapixel camera's

Package Contents
AXONE Nemo including IDC5 Premium Car & Supercar Software
NAVIGATOR NANO S
AXONE NEMO Stand
OBD Extension Cable



**CALL FOR
MORE INFO**

Designed specifically for the CAR & BIKE platform

The **Axone 5** is TEQA's Latest Diagnostic tablet to be added to its extensive product range. The **Axone 5** has been specifically designed for the Car & Bike platforms. Running the new IDC5a software, developed especially for the **Axone 5**, it is packed full of features to prepare workshops for the future. The latest-generation 9.7-inch capacitive touchscreen with a resolution of 2048x1536 pixels guarantees ultimate definition, touch precision and ease of use.

The **Axone 5** is robust and practical outside but powerful and intuitive inside with its exceptional technical features, together with its user-friendliness, ensuring quick and effective diagnosis.

**INCLUDING 1 YEAR
CAR TEXPACK,
& 2 YEARS WARRANTY**

Axone 5
Car/LCV Nano S VCI
£2,475
Weekly from: £13.14*

Package Contents
AXONE 5 including IDC5a Plus Car Software
NAVIGATOR NANO S
OBD EXTENSION CABLE



Part No:
UKD2421



MASTER RCCS HARDWARE KIT



PLEASE NOTE ADDITIONAL BOARDS MAY BECOME AVAILABLE TO SUPPORT ADDITIONAL SYSTEMS & MANUFACTURERS

RCCS EQUIPMENT

RCCS CALIBRATION RIG	2x SELF CENTERING WHEEL CLAMP
2x LASER HEADS	2x LASER SUPPORT
DIGITAL MEASURE	DIGITAL CENTERING LASER
DIGITAL LEVELLING BOX	

CALIBRATION PANELS

POSITIONING MAT	RENAULT / SMART
MERCEDES TYPE 1 REAR	ALFA ROMEO TYPE 1 FRONT
VAG FRONT	MERCEDES TYPE 2 REAR
KIA / HYUNDAI / FIAT / JEEP FRONT	NISSAN FRONT
VAG REAR	MAZDA FRONT
TOYOTA TYPE 2 FRONT	TOYOTA TYPE 1 FRONT
HONDA TYPE 2 FRONT	HONDA FRONT
NISSAN / INFINITY FRONT	MAZDA TYPE 2 FRONT
MERCEDES FRONT	SUBARU / SUZUKI FRONT

DELIVERY & INSTALLATION IS AVAILABLE AT AN ADDITIONAL COST

Prices are correct at the time of printing and are subject to change without prior notice. All prices exclude VAT.

BOSCH DIAGNOSTICS



ONLY
£1,595

Weekly from: £8.46[†]

What's included in the Masterpack & EBR subscription

- SD - Vehicle diagnosis**
 - The latest diagnostic data for passenger cars and light commercial vehicles for over 130 brands.
- SIS - Vehicle troubleshooting instructions**
 - The troubleshooting instructions reliably guide you step-by-step to the cause of the fault.
- EBR/TSB - Experience-Based-Repair - Known Fixes**
 - Find the right solution within seconds, even for challenging troubleshooting cases. Includes the module - technical service bulletins (TSB).
- M - Vehicle mechanics and maintenance schedules**
 - Maintenance information tabs contain all vehicle data such as service schedules, needed parts and much more with direct link to diagnostic functions.
- P - Comfort systems wiring diagrams**
 - Giant database including wiring diagrams for all important systems such as engine management, comfort systems and bus systems for optimal efficiency.

The Bosch KTS 590

Optimally suited for the use of the diagnostic software ES[tronic] 2.0, the Bosch KTS 590 can operate several vehicle interfaces in parallel so vehicle manufacturer portals for diagnostics and reprogramming according to Euro 5/6 (PassThru) can be operated efficiently. In the future, parallel communication on various vehicle interfaces (incl. Ethernet) is a must for ambitious workshops.



PACKAGE 1

KTS 590 +
1 YR SD/SIS
SOFTWARE

£2,795

Weekly from: £14.84[†]



PACKAGE 2

KTS 590 AND DCU100
TABLET WITH MASTER-
PACK & EBR SOFTWARE

£3,995

Weekly from: £17.52[†]

PACKAGE 3

KTS 590 + DCU 220 +
1 YR MASTERPACK
& EBR SOFTWARE

£5,595

Weekly from: £29.70[†]



Stay up-to-date

- New vehicle models are available in ES[tronic] 2.0 with coverage, as soon as six months after their market launch
- Online (intermediate) updates available, which run silently in the background with no user intervention required
- Updates also available to install via DVD



Efficient overall package for control unit diagnosis, maintenance, troubleshooting and repair

With a more powerful processor (4 GB RAM, 256 GB SSD) and in conjunction with the Windows 10 operating system, the program starts quickly and works faster. It is versatile and ideal as an all-in-one tester for independent workshops or as a second device for mobile usage.

- Mobile all-round solution:** control unit diagnosis, troubleshooting, repair and maintenance
- Support of all current vehicle interfaces based on Ethernet and parallel operation of several BUS systems
- PassThru interface for programming the control units on the portals of the vehicle manufacturer as per Euro 5/6
- Plug & play through the pre-installed and configured application ES[tronic] 2.0
- 45 second system start thanks to the improved processor and modern SSD technology
- Regular online updates available
- Windows 10 operating system allows easy installation of additional applications

£500 TRADE IN OFFER AVAILABLE*

Advanced technology in one compact device

ONLY
£3,495

Weekly from: £18.55[†]

*£500 trade in for any old diagnostic unit. EOBD & Code Reader excluded.

ADAS PACKAGES

Additional entry model for multi-brand camera calibration.
Wide ADAS coverage with ESI [tronic] 2.0 - Online.

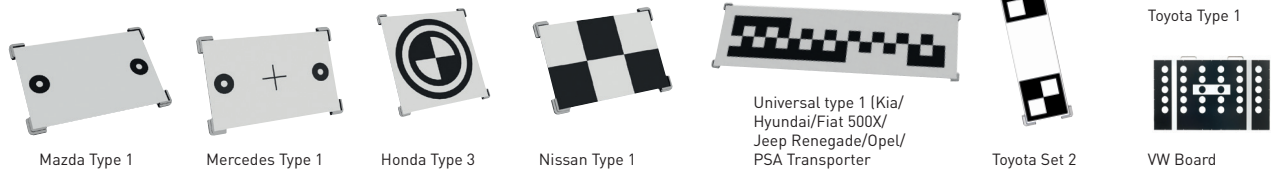

PACKAGE 1

- SCT 415 Adjustment jig with line Laser for center line positioning
- Starter Kit 1 that includes 7 target boards



- VW Board
- Training x2
- Calibration

ONLY £7,495

Weekly from: £39.78*

PACKAGE 2

- SCT 415 Adjustment jig with line Laser for center line positioning
- Starter Kit 1 that includes 7 target boards



- VW Board
- Training x2
- Calibration
- SCT 815 S1

ONLY £8,795

Weekly from: £46.68*

PACKAGE 3

- SCT 415 Adjustment jig with line Laser for center line positioning
- Starter Kit 1 that includes 7 target boards



- VW Board
- Training x2
- Calibration
- SCT 815 S1
- KTS 590
- DCU 100

ONLY £12,395

Weekly from: £65.79*

2 DAY ADAS TRAINING DAY FOR ONE TECHNICIAN ABSOLUTELY FREE WITH ANY ADAS PACKAGE!

Bosch Professional Air Conditioning Machines

ACS 511 Fully Automatic Air Conditioning Service Unit

- 8Kg integral tank
- Powerful two-phase vacuum
- Integrated flushing programme
- Easy internal filter maintenance
- Guided performance test for A/C system
- Accessible vacuum pump for easy oil change
- Fully automatic or single service process selectable
- Integrated database for car, truck and commercial vehicles
- 2 year manufacturer warranty supported by Bosch engineers



ONLY £1,995

R134A

Weekly from: £10.59*

ACS 561 Fully Automatic Air Conditioning Service Unit

- High-performance deep vacuum function
- Integrated flushing program with optional kit
- Fully automatic or single service process selectable
- Time-saving and precise service on modern R-1234yf air conditioning systems
- Service hoses with flushing function for hybrid/electrical systems compatibility
- 2 year manufacturer warranty supported by Bosch engineers



ONLY £2,495

R1234YF

Weekly from: £13.24*

USE THE
BEST
TO TEST!



BAT 131
£599.00
Weekly from: £3.18[†]

MARKET
LEADING
BATTERY
TESTER

BAT 131 BATTERY TESTER

With integrated printer

Perfectly suitable for testing 6 V and 12 V starter batteries (lead-acid, gel and fleece batteries / AGM). The stress-free test process leads to quick, precise and reliable measurement results.

BENEFITS AT A GLANCE

- Optimized test algorithm to test new, unused and in-stock batteries
- Extended test of the start/charge system for 12v and 24v batteries.
- Saves up to 100 test results; USB port to download test results and future software updates
- Replaceable 3 m cable that allows flexible working

MODERN TEST EQUIPMENT
STRENGTHENS THE
WORKSHOP'S EXPERTISE

UNIVERSAL BATTERY CHARGERS

Fully automated charging,
back-up and buffer mode



BAT 645
£745.00
Weekly from: £3.95[†]

MARKET
LEADING
BATTERY
CHARGERS

BAT 645 & BAT 690 BATTERY TESTERS

State-of-the-art equipment
for your workshop

SHARED FEATURES

- 45 A or 90 A – for all lead acid battery types (standard, maintenance-free, gel, fleece, AGM, EFB) and new Li-Ion – Lithium Iron Phosphate (LFP)
- Fully automatic charging characteristics – universal for all battery types (UNI) and specific characteristics for WET, AGM, GEL, EFB and LFP and soft charging phase for deeply discharged batteries (automatic)
- Backup mode – maintains voltage supply to buffer data (e.g. car stereos, supply and control units, etc.) during battery replacement
- Buffer mode – keeps SOC of the battery and stabilizes vehicle electrical systems (engine is off)
- HMI with a dot matrix display – 18 languages
- Electronic protection management system
- USB port for SW updates
- Exchangeable charging and power cord cables
- Charger holder for wall mounting

BAT 690
£1,215
Weekly from: £6.45[†]

CALL FOR
MORE INFO

**EXHAUST
GAS STATION**

**The Premium Exhaust
Gas Station for the
highest demands**

BEA 950 S1

- Premium emissions test station for demanding workshops
- Sturdy construction
- Bluetooth connection between PC, BEA 030 and KTS 515
- Optional battery operation with diesel smoke-head (BEA 070)
- Short setup and warmup times
- **Modular expendable solution:**
works with control unit diagnosis, ESI[tronic] troubleshooting instructions and FSA vehicle system analysis options
- Supports the Bosch workshop networking concept Connected Workshop
- Fully approved DVSA software

**EASY, TIME-SAVING AND
CLEAN WORK WITH THE
BOSCH EMISSION ANALYSERS**

STAR BUY

BEA950 S1
£5,995
Weekly from: £31.82*

**CALL FOR
MORE INFO**

**Innovative solutions for a
cleaner and safer environment**

**TPA 200
DIAGNOSTIC TOOL**

**Timesaving tyre service
and reliable diagnoses**

**Benefit from reliable diagnosis and efficient
service concerning everything about the
TPMS tyre with the diagnostic tool TPA 200:**

- Activation and check of TPMS-sensors
- Programming of universal-sensors
- Activation of schrader-sensors
- Specific TPMS-Sensor Audit-Functions
- Programming of workshop specific workflows
- Wireless data transfer
- Compatible with direct TPMS as an addition to ESI[tronic] and KTS control unit diagnosis

TPA 200
£375.00



BOSCH
Invented for life



Software

- A huge application list covering European and Asian vehicles with in-depth testing
- 3 major updates per year
- Detailed instructions and help to assist with complex programming functions
- Report function creates a professional printout for customers

DS150E/450E SOFTWARE

£595.00

(1 YEAR) DELSV10516†

DS150E/450E SOFTWARE

£1,345.00

(3 YEAR) DELSV10598†

Delphi Technologies

GRAB YOURS NOW!!

DS150E Hardware Kit

Delphi Technologies



DELSV10546

- All makes, easy to use diagnostic tester
- Covers European & Asian vehicles to current date
- Fault codes, live data, actuator operation, coding functions and service re-sets
- 2GB Flight Recorder
- Illuminated 16 pin connector
- Works with most laptops and PC's inc Windows 10
- Free Manufacturer user training

VCI TRADE IN DEAL £1,550 INC. SOFTWARE (SAVING OF £320)

VCI Exchange Part No: SV10546EX

ONLY £1,870 inc 1 year Software

Weekly from: £9.93†

DS450E Tablet and Mini VCI Kit UK

Delphi Technologies



DELSV11438

NEW modern tablet

- VCI as DS150E
- Rugged case built for protection against six foot drop/shock, dirt and vibration
- Bluetooth wireless technology
- 10.1" HD LED IPS anti-glare screen for better visibility
- 1.2MP front-facing webcam and 5MP rear-facing camera
- Latest tablet computing with Windows 10 Pro 64 operating system

ONLY £2,990 inc 1 year Software

Weekly from: £15.87†

DS-Flash Full Kit

Delphi Technologies



DS Flash now available without a battery support unit (BSU) part number - SV60123

Saving of £400 on SV60012

ONLY £5,345

- Perform dealer-level diagnostics (where offered by the vehicle manufacturer)
- Download software updates including emission-related ECUs
- ECU updates for a wide range of vehicle makes and models
- Update Digital Service Records (DSR)
- Access OE technical data and service schedule information
- Includes battery support unit (BSU) and laptop
- Now officially supports Jaguar Land Rover

ONLY £5,745

Weekly from: £30.49†

Vehicle Technical Information

▶ **Basic Pack: £150.00**

Part No: SV11509

▶ **DS User Ultimate Pack: £495.00**

Part No: SV11510

▶ **Standalone Ultimate Pack: £525.00**

Part No: SV60135

Basic Pack:

- ▶ Identification
- ▶ Maintenance
- ▶ Repair manuals
- ▶ Adjustment data
- ▶ Lubricants & fluids
- ▶ Recalls



FREE WITH FREE WITH DS SOFTWARE SUBSCRIPTION



Ultimate Pack + Technical Pack + Smart Pack + Basic Pack:

- ▶ VESA (guided diagnostics of components)
 - 90% of UK vehicle parc coverage
- ▶ Repair times
- ▶ Comfort wiring diagrams



NOW WITH VRM LOOKUP

LP35 Kit

DEDYDT810

Highly precise, fast and cost effective hand held tester for the low pressure circuits of any vehicle.

- Able to test the pressure of fuel, oil, additives and air.

ONLY
£1,225

Weekly from: £6.50*



Delphi
Technologies

Electronic Injector Test Kit 'Buzz Tool'

- Quickly performs an electronic diagnosis on the common rail injector solenoid on or off the vehicle

ONLY
£1,340

Weekly from: £7.11*



DEDYDT720

Common Rail Diesel Diagnostics

DEDYDT732

Common Rail Diagnostic Tool Kit DEDYDT850

- Measures pressure created by the CR pump
- On-vehicle testing
- Measure injector back-leakage

£895.00

Dummy Actuator Kit DEDYDT410

- Diagnose actuator failures within Common Rail pumps
- Replaces the pump actuator with a false actuator forcing it to deliver full pressure

£295.00

Bosch CP4 False Actuator DEDYDT747

ONLY
£995.00

Weekly from: £5.28*

CALL FOR MORE INFO



Delphi
Technologies



DEDYDT-35B

Common Rail Injector Function Tester (with Backleak)

ONLY
£3,995

Weekly from: £21.20*

Delphi
Technologies

Tests diesel injectors types from major manufacturers:

- Delphi, Denso, and Bosch solenoid
- Denso, Bosch, and Continental Piezo
- Bosch CRIN and Denso Heavy Duty adapters (optional)
- Electrical injector tests
- Nozzle spray-pattern visual observation
- Includes Calibration Fluid
- Resistance, Induction and Capacitance

CALL FOR MORE INFO

FREE 20LTR CALIBRATION FLUID
(WHILE STOCKS LAST)

Common Rail Backleak Kit

Delphi
Technologies

- 11 all makes back leak connectors
- Replacement O rings
- 3 types of blanking plug
- Convenient storage case
- Replenishment packs available

DEDYDT586

ONLY
£185.00

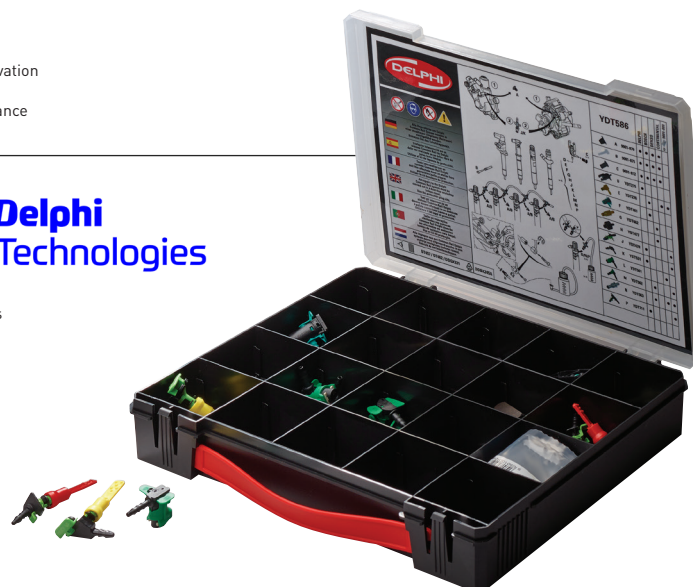

2 YEARS INCLUSIVE UPDATES WITH THE MS908S & MS906

Limited availability – Updates normally 12 months

✓ **24 Months Update**
Until 31st March 2019

✓ **12 Months Support**

✓ **EU Enhanced Software**

NOW INCLUDED

MAXISYS MS908S
£0.00

Normally ~~£745.00~~



✓ **24 Months Update**
Until 31st March 2019

✓ **12 Months Support**

✓ **EU Enhanced Software**

NOW INCLUDED

MAXISYS MS906
£0.00

Normally ~~£475.00~~



✓ **12 Months Update**

✓ **12 Months Support**

✓ **EU Enhanced Software**

MAXISYS MS908S PRO
£1,195.00



MAXISYS MS908S

The MaxiSys MS908S is built on the multi-tasking Android operating system

- Bluetooth VCI Connectivity
- 70+ Manufacturers
- TPMS Diagnosis and Programming
- Built-in rechargeable lithium-ion battery for up to 8 hours of continuous operation
- Read & Clear Codes
- Live Data/Record/Playback
- Auto Vin & All Module Interrogation
- SAS/BMS/DPF Service Functions
- Electronic Parking Brake
- Service Mileage/Interval Reset
- European software

The MaxiSys MS908S is the UK's best selling premier Autel diagnostic tool with a 15 second boot up speed built on the multi-tasking Android operating system.

The MS908S includes a number of great features covering over 60 manufacturers with full diagnostics, service function and programming, 8 Mega-pixel Camera, 64GB Internal Hard Drive and Wireless Bluetooth diagnostics via the Vehicle Communication Interface (VCI).

Both the MS908S & MS908S PRO are supplied with Pre-16 pin OBD connectors for the older vehicles

15 SECOND BOOT UP

BUILT ON ANDROID OPERATING SYSTEM

Fully upgradeable with the following bolt-ons:

- Upgradable to ADAS
- Add an MP408 oscilloscope
- Add an MV105 borescope
- Add a pass-through J2545 to standard MS908

- Wireless Bluetooth VCI
- Android Powered
- 8 Mega-pixel Camera
- 9.7" 1024 x 768 Screen
- 64GB SSD Hard Drive
- Chrome Web Browser
- Portable Tablet Device
- 8 Hour Battery Life

9.7" LED MULTI-TOUCH DISPLAY

MAXISYS MS908S
£1,995

Weekly from: £10.59*

- Autel products meet international quality and environmental regulations, including as FCC, CE and RoHS



NOW IVECO DAILY COMPATIBLE

MAXISYS MS908S PRO+J2534

The MaxiSYS MS908S Pro with J2534 has extra programming functionality included in the tools software and also allows you to subscribe to your manufacturer clouds and download software specifically for a vehicle. The MS908S Pro with the optional extra J2534 pass through device allows even greater in-depth vehicle programming, making it ideal for the more specialist repair garages and bodyshops.

- Perform dealer-level diagnostics (where offered by the vehicle manufacturer)
- Download software updates including emission-related ECUs
- ECU updates for a wide range of vehicle makes and models
- Access OE technical data and service schedule information

Fully upgradeable with the following bolt-ons:

- Upgradable to ADAS
- Add an MP408 oscilloscope
- Add an MV105 borescope

Autel Pass Thru Technology with the J2534 Pass through device

In addition to all the features found on the MaxiSys MS908, the MS908 PRO and J2534 offers further diagnostic capability with a Higher Level of Programming functions along with pass-through capability including Key Programming.



The most extensive system coverage for 70+ manufacturers



MAXISYS MS908S PRO
£2,495

Weekly from: £13.24*

MAXISYS™

Our all new ADAS Calibration System offers advanced calibration for Camera, Radar, Lidar and Ultrasound based systems. Our Autel calibration frame is compatible with vehicle leveling lifts & is fully height adjustable. The frame is of superior quality and compatible with existing Autel MS908, MS9008Pro and Elite diagnostic tools.

ALREADY HAVE AN MS908? IF SO, THEN UPLOAD THE ADAS SOFTWARE WHEN YOU BUY THE FRAME...SAVING YOU MONEY!

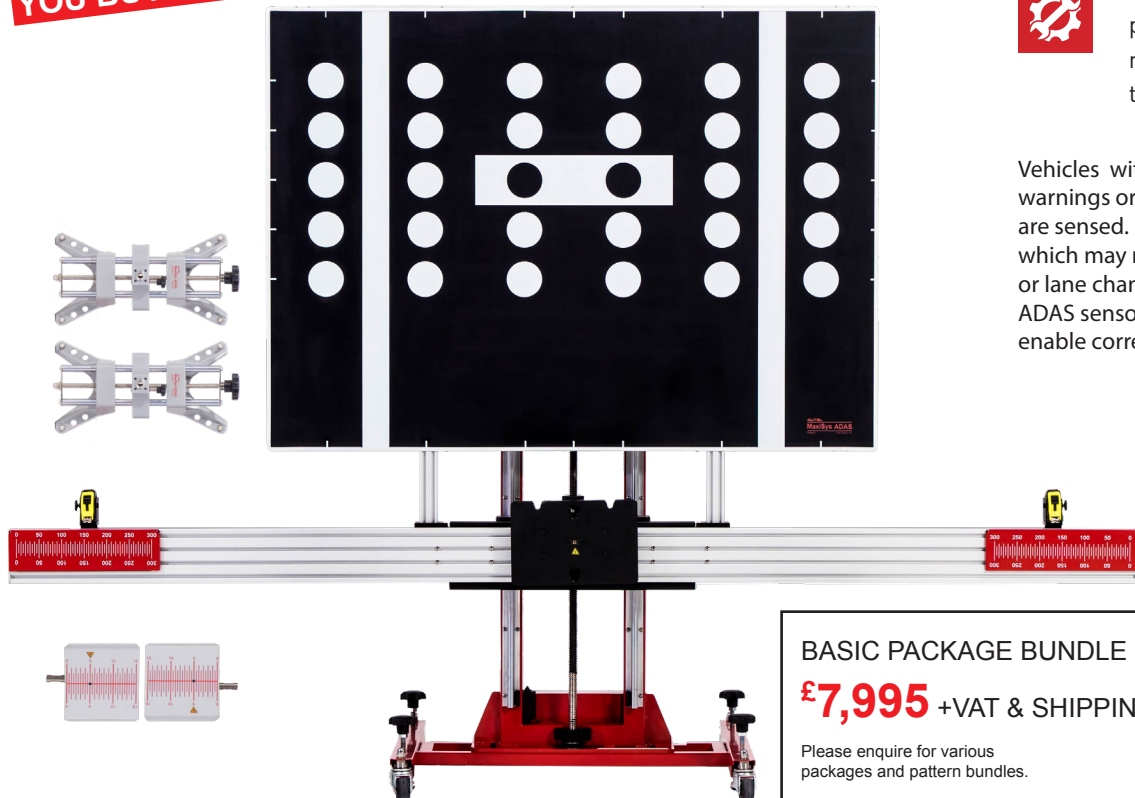

BASIC PACKAGE BUNDLE
£7,995 +VAT & SHIPPING.
 Please enquire for various packages and pattern bundles.

PASSIVE FEATURES

ALERT THE DRIVER OF DANGEROUS SITUATIONS

ACC		ADAPTIVE CRUISE CONTROL
LDW		LANE DEPARTURE WARNING
NVS		NIGHT VISION SYSTEM
BSD		BLIND SPOT DETECTION
AVM		AROUND VIEW MONITORING
RCW		REAR COLLISION WARNING
HUD		HEAD-UP DISPLAY

ACTIVE FEATURES

COLLISION AVOIDANCE SYSTEMS

AUTOMATIC EMERGENCY BRAKING
LANE KEEPING ASSIST
ADAPTIVE FRONT LIGHTING
BLIND SPOT INTERVENTION
PEDESTRIAN PROTECTION SYSTEM
AUTOMATIC PARKING
DRIVER DROWSINESS MONITOR

SEE OUR ADAS VIDEOS AT WWW.AUTEL.UK FOR MORE INFO

ADAS

ADVANCED DRIVER ASSISTANCE SYSTEM
CALIBRATION
TOOL PACKAGE



Weekly software updates provide new OE level model calibration procedures.



Comprehensive coverage and guided procedures guarantee precise measurements without referring to a user manual.

Vehicles with ADAS systems can respond with passive warnings or take active measures where driving risks are sensed. ADAS sensors process events and obstacles which may result in, for example, automatic braking or lane change warnings. After repairing a vehicle, all ADAS sensors & systems need to be re-calibrated, to enable correct operation.

COMPLETE SET-UP AND CALIBRATION INSTRUCTIONS



FRAME POSITIONING



WHEEL CLAMP SETUP



LASER LEVELING FRAME

WHAT'S POWERING YOUR WORKSHOP?

LATEST IN DIAGNOSTIC TECHNOLOGY

BENDIX DIAGNOSTIC & SERVICE TOOL

In-depth software including a vast vehicle coverage and powerful specialist test functions, extremely fast live data and graphing, along with module coding capabilities.

INTEREST FREE
OPTIONS AVAILABLE
(subject to terms and conditions)

COMES COMPLETE WITH
BMW & MERCEDES
ROUND PIN ADAPTERS

TRADE IN OFFER

£500

OFF WHEN YOU TRADE IN
ANY DIAGNOSTIC SCAN TOOL

**ALL NEW
10" TABLET**

**INCLUDES
12 MONTHS
UPDATES**



~~Normally £2,295~~

£1,995

Weekly from: £10.59⁺

Part No:
989AA0650

**FOR MORE DETAILS OR TO ARRANGE A
DEMONSTRATION CONTACT YOUR LOCAL BRANCH**

**SUPER
FAST**

**UNBEATABLE
VALUE**

- 12 months UK support
- UK & European software

**PARTS ALLIANCE
DIAGNOSTICS**



VCDS® HEX-V2 INTERFACE

HEX-V2: The new generation VCDS® interface

FOR ALL VAG GROUP MODELS

Official licensed VCDS HEX-V2 interface & USB cable

Serious car diagnostics interfaces for Volkswagen, Audi, Seat & Skoda models

The Ross-Tech VCDS® package (previously known as VAG-COM) turns your PC into a sophisticated VAG diagnostic tool, that performs the functions of a factory VAG scan tool. The new generation wired VCDS has been designed to replace the HEX-USB+CAN and Micro-CAN products.

- Includes Official Ross-Tech® HEX-V2 interface and USB cable
- Fully licensed for VCDS® Software, no additional software purchase needed
- Professional user level interface - unlimited VINs
- Fully licensed with Ross-Tech®, Fast scans
- User replaceable USB cable
- Resets Service and Inspection Reminders even on 2018 models.
- Compatible with Windows PCs and Laptop running Windows 7, 8 and 10

THE NEW VCDS INTERFACE'S ARE NOW THREE TIMES FASTER!!

Ross-Tech® VCDS® with HEX-V2 works on all diagnostic capable systems on:

- VW cars and light vans to current 2018 models (not Crafter van*)
- SEAT cars and light vans to current 2018 models
- SKODA cars and light vans to current 2018 models
- Audi cars to current 2018 models
- Note, very early car models (mostly pre 1998) with the 2 pin connectors, or LT vans with a round connector need an additional adapter
- *Coverage for Crafter van will be added in a future update

NEW

VCDS® HEX-V2 INTERFACE ONLY

HEX-V2
(INTERFACE ONLY)
Part No: 989AA0080



ONLY
£395.00

VCDS® HEX-NET INTERFACE

HEX-NET: The new generation VCDS® interface

The Ross-Tech® VCDS® HEX-NET USB & WiFi interface for additional platforms

The new VCDS HEX-NET has the same functionality as the VCDS HEX-V2 (above) but can also operate on: Apple iPad® and iPhone®, Android® Tablets and phones, Microsoft Surface® along with other devices with WiFi capabilities such as KindleFire®. (Higher functions such as service reset etc can also be performed on mobile devices but require an internet connection).

THE POWER OF VCDS IN A WIRELESS INTERFACE

FOR ALL VAG GROUP MODELS

IDEAL FOR TABLET USERS*
(TABLET NOT INCLUDED)

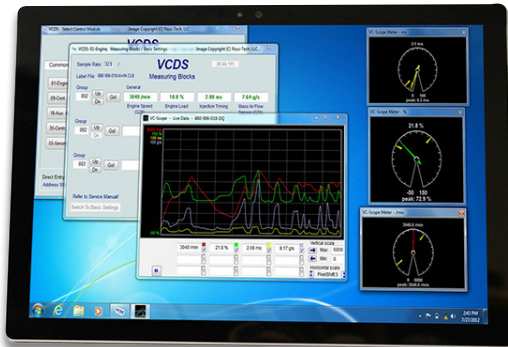

VCDS® HEX-NET INTERFACE ONLY

HEX-NET
(INTERFACE ONLY)
Part No: 989AA0090



ONLY
£525.00



HEX-V2 PROKIT
Part No: 989AA0011

ONLY
£475.00



HEX-NET
PROFESSIONAL KIT
Part No: 989AA0280

ONLY
£569.00

AIR CON KRISTAL BASE

R1234YF Fully Automatic Air Con Service Station

Machine Components

- 10 Litre cylinder capacity
- 1 electronic scales for gas
- Automatic oil/UV dye injection
- Comprehensive vehicle database
- Self service replacement filters
- 2.5m charging line with couplings
- Refrigerant tank lock

Dashboard Facilities:

- High contrast back-lit digital display
- Membrane keypad
- Quick stop safety button
- Thermal printer

Includes:

- Free F Gas Training for one person
- Free delivery and commissioning
- Free technical helpline

STARTER PACK

Special Price £599 +VAT

Part No: CEACC3K



DIAGNOSTIC PACK

Special Price £170 + VAT

Part No: CEACC4K



Terms and conditions apply. The machine must be serviced after Year 1 and Year 2.



MACHINE ONLY PRICE Part No: CE92009KB

£2,495

Weekly from: £13.24†

CALL FOR MORE INFO

COMPLETE AIR CON PACKAGE

ONLY

£2,995

Weekly from: £15.90†

CTR
DENSO THERMAL SYSTEMS

AIR CON KHEOS PLUS

R134A Fully Automatic Air Con Service Station



MACHINE ONLY PRICE Part No: CE92006KP

£1,899

Weekly from: £10.08†

City & Guilds
Approved Centre

Safe Handling of Refrigerants
Certification City and Guilds 7543 - 01

(This Certification meets the above EU Directive)

ASSESSMENTS FROM £220+VAT

(Per Technician - Discounts available for Multiple Assessments)

Machine Components

- Fully programmable
- Comprehensive vehicle database
- 10KG refrigerant cylinder
- Easy read pressure gauges
- Automatic recovery / vacuum / charge
- Automatic oil discharge
- 100L/min vacuum pump
- 400G per min recovery pump
- Counters for machine servicing
- Heater blanket

Dashboard Facilities:

- High contrast back-lit digital display
- Membrane keypad
- Quick stop safety button
- Thermal printer
- Language selection

Includes:

- Free F Gas Training for one person
- Free delivery and commissioning
- Free technical helpline



Terms and conditions apply. The machine must be serviced after Year 1 and Year 2.

NEW AIR CON LEGISLATION

FROM 1ST JANUARY 2015
A NEW EU DIRECTIVE NO:
517/2015 F GAS REGULATION 2

NEW

STARTER PACK Special Price £130 + VAT Part No: CEACC5K



DIAGNOSTIC PACK Special Price £170 + VAT Part No: CEACC6K



COMPLETE AIR CON PACKAGE

ONLY

£1,995

Weekly from: £10.59†

HOT WATER HIGH PRESSURE CLEANER

With water flow of up to 700 litres per hour, and up to 100 bar pressure, the 7/10 is a great all-round machine with superb performance for daily and deep cleaning jobs.

Technical Specification

Voltage:	240v
Flow rate (l/h):	350-700
Pressure bar / MPa	30-100 / 3-10
Max. temperature °C	155
Power rating kW	3.4
Consumption fuel oil kg/h	4.6
Fuel tank l	25
Weight kg	146
Dimensions (L x W x H) mm	1330, 750, 1060

FREE SITE SURVEY

OFFERS FUEL SAVINGS OF UP TO 20%



Model No:
HDS 7/10-4M

ONLY £2,795

Weekly from: £14.84*

HOT WATER HIGH PRESSURE CLEANER

Single-phase (240 V) HDS 6/12 C hot water high-pressure cleaner with eco/efficiency mode, Easy Press trigger gun and Servo Control, the infinitely variable pressure and water flow regulation function from Kärcher.

Technical Specification

Power supply (Ph/V/Hz):	1/240/50
Water Flow rate (l/h):	240-560
Operating Pressure (bar/MPa)	30-100 / 3-10
Max. temperature °C	80/155
Connected load (kW)	3.0
Consumption fuel oil kg/h	3.5
Fuel tank (l)	15.5
Weight (kg)	108.1
Dimensions (L x W x H) mm	1060 x 650 x 920

GREAT VALUE HOT WATER PRESSURE WASHER WITH STEAM MODE

SAVES ENERGY & TIME



Model No:
HDS 6/12 C

ONLY £1,999

Weekly from: £10.61*

HIGH PRESSURE WASHER

Equipment details: Carrying handle, brass cylinder head and automatic pressure relief. For vertical and horizontal operation.

Technical Specification

Current type Ph / V / Hz	1 / 240 / 50
Flow rate (l/h):	490
Operating Pressure bar / MPa	110 / 11
Max. pressure bar / MPa	160 / 16
Max. water feed temperature °C	max. 60
Power rating kW	2, 2
Weight kg	20, 5
Dimensions (L x W x H) mm	351, 312, 904

PARTS ALLIANCE BEST BUY!



COMPACT, LIGHT & MOBILE

Model No:
HD 5/11 P

ONLY £499.00

CARPET & UPHOLSTERY CLEANER

Spray extraction cleaner for upholstery

IDEAL FOR DAILY USE

The powerful and compact Puzzi 8/1 C enhances Kärcher's spray extraction range as it is ideal for upholstery cleaning of carpeted floors. Due to the excellent suction power, the Puzzi 8/1 C leaves carpets and upholstery virtually dry to touch in minutes. It's lightweight construction means this unit can be transported easily from one place to another perfect for use in hotels, hospitals, shops and the automotive industry.



Model No:
Puzzi 8/1

ONLY £449.00

Technical Specification

• Spray Rate:	1 litre per minute
• Air Flow:	61 litres per minute
• Fresh/Dirty Water Capacity:	8/7 litres

WET & DRY VACUUM CLEANER

High Performance Wet & Dry Vacuum Cleaner



The NT27/1 is a robust and powerful all-purpose vacuum cleaner designed for professional applications and perfect for the automotive industry supplied with inter-changeable floor tool for wet or dry use, and a sock to protect the filter when picking up liquids. Perfect for cleaning vehicles, workshop spills and more.

POWERFUL ALL-PURPOSE VACUUM



Technical Specification

- Capacity: 27 litres
- Air Flow: 67 litres/sec
- Power: 1380W (240V)

ONLY **£195.00**

Model No: NT 27/1

FLOOR CLEANER RM 69 ASF

Powerful cleaner, effortlessly removes stubborn oil, grease, soot and mineral soiling from floors and industrial floors.

MAKES UP TO 2000 LITRES OF SOLUTION*

Application method

- Scrubber-dryers
- Manual

Properties

- Powerful basic cleaner for heavily soiled industrial floors
- Dissolves heavy oil, grease and mineral stains
- Pleasant, fresh fragrance
- Effective quickly
- Rapidly separates oil/water in the oil separator (easy to separate=ASF)
- NTA free
- 20L

Directions for use:

- Test on an inconspicuous area for material compatibility
- Do not apply to wood, linoleum or unsealed parquet flooring
- Do not apply to alkali-sensitive surfaces
- Do not let the cleaning
- Store away from frost



NTA-free

ONLY **£59.00**

Model No: RM 69



*when used at the average dosage rate of 1%

HEAVY DUTY FLOOR SCRUBBER

Advanced Professional Heavy Duty Floor Scrubber/Dryer

Technical Specification

- Working Width: 400mm
- Fresh/Dirty Water Tank: 10/10 litres
- Brush Speed: 1100 rpm
- Power: Mains (240v)

Powerful and fast

- Two high-speed roller brushes with high contact pressure
- Two squeegees remove water forwards and backwards
- Floors dry very quickly

Low reach

- Easily reaches under furniture
- The push handle can be folded in both directions
- Removable tank - suitable for low lying objects

Service-friendly

- Squeegee and brush are easy to replace without tools
- Water distributor strip is easy to remove and clean
- All electrical components are quickly and easily accessible

Ergonomic handle

- For easier use
- With integrated water flow and brush control
- Ideal for transporting and storage

ONLY **£1,795**

Weekly from: £9.53*

Model No: BR40/10 Adv



BOOK A DEMO TODAY

WORKSHOP FLOOR CLEANING

For efficient basic and maintenance cleaning of areas up to 900 m²

Technical Specification

- Working width: 430mm
- Suction width: 850mm
- Input power: 1100W
- Brush Speed: 180 rpm
- Brush contact pressure: 30 - 40g / cm
- Fresh and recovery tank: 35 L
- Dimensions (L x W x H): 1136 x 516 x 1030mm
- Weight (net): 48 kg
- Power: Mains (240v)

- Small and compact design with a clear overview and high capacity
- User friendly easy operation switch

Model No: BD 43/35 Ep

ONLY **£1,895**

Weekly from: £10.06*

LARGE TANK CAPACITY



FREE SITE SURVEY

Champion Compressors

Champion, the smart and affordable compressed air solution have an exclusive partnership with the Parts Alliance to offer the most comprehensive range of compressors and air treatment in the UK automotive sector.



PISTON MODELS

A comprehensive range of over 400 piston models from 1.1 to 22 kW including tandem, engine driven, base plate and silenced.



ROTARY SCREW MODELS

Fixed or Variable Speed Drive, the rotary screw compressor range is available from 2.2 to 75 kW, floor mounted, receiver mounted with or without refrigerated dryer and optional factory fitted filtration pack.



WARRANTIES

Champion offer a 2 year standard warranty for all piston and screw compressors with the option of an extended warranty for all rotary screw models.



COMPRESSORS FROM JUST **£359.95**



CALL FOR MORE INFO

BELT DRIVEN LUBRICATED CHAMPION PRO SERIES



MADE IN ITALY



50L



CP28B-50-CM3-UK
Belt Driven Lubricated 13 Amp Air Compressor



200L

CP28B-200-CM3-UK
Belt Driven Lubricated 13 Amp Air Compressor

The CP28B-50-CM3 & CP28B-200-CM3 are both highly portable, fully automatic, single phase 13 amp professional compressors.

BELT DRIVEN SINGLE STAGE LUBRICATED - PRO SERIES

Part No.	Model	Capacity		Pressure		Motor		Receiver	Noise	Volt	Offer Price	5yr Lease Price
		CFM	L/min	Bar	Psi	HP	kW					
CC55900015NCUK	CP28B-50-CM3-UK	10.4	295	10	145	3	2.2	50	76	230	£399.00	£2.12
CC55900023NCUK	CP28B-100-CM3-UK	10.4	295	10	145	3	2.2	100	76	230	£429.00	£2.28
CC55900031NCUK	CP28B-150-CM3-UK	10.4	295	10	145	3	2.2	150	76	230	£459.00	£2.44
CC55900039NCUK	CP28B-200-CM3-UK	10.4	295	10	145	3	2.2	200	76	230	£549.00	£2.91

FEATURES

- Single Phase, 13 amp supply
- Highly portable
- Fully automatic
- Quick release couplings
- 2 year standard warranty

BELT DRIVEN 230V LUBRICATED CHAMPION ADVANCED SERIES



MADE IN ITALY

NEW

200L



PARTS ALLIANCE EXCLUSIVE

2 YEARS

CA28B-200-CM3-UK
Belt Driven
230v Lubricated
13 Amp Air
Compressor

FEATURES

- Single Phase, 13 amp supply
- Superior pump unit
- Highly portable
- Fully automatic
- Quick release couplings

ROBUST STEEL GUARDS

BELT DRIVEN SINGLE STAGE LUBRICATED - ADVANCED SERIES

Part No.	Model	Capacity		Pressure		Motor		Receiver	Noise	Volt	Offer Price	5yr Lease Price
		CFM	L/min	Bar	Psi	HP	kW	Litres	dB(A)			
CC55901143NCUK	CA28B-150-CM3-UK	10.4	295	10	145	3	2.2	150	76	230	£549.00	£2.91
CC55901175NCUK	CA28B-150-CT3-UK	10.4	295	10	145	3	2.2	150	76	400	£549.00	£2.91
CC55901151NCUK	CA28B-200-CM3-UK	10.4	295	10	145	3	2.2	200	76	230	£569.00	£3.02
CC55901183NCUK	CA28B-200-CT3-UK	10.4	295	10	145	3	2.2	200	76	400	£569.00	£3.02

BELT DRIVEN TANDEM LUBRICATED CHAMPION PRO SERIES

FEATURES

- Single Phase, 30 amp supply
- High capacity
- Controller
- 2 year standard warranty

PARTS ALLIANCE EXCLUSIVE

RELIABLE, STRONG & LONG LASTING



300L

NEW

CALL FOR MORE INFO

MADE IN ITALY

2 YEARS

BELT DRIVEN TANDEM LUBRICATED - PRO SERIES

Part No.	Model	Capacity		Pressure		Motor		Receiver	Noise	Volt	Offer Price	5yr Lease Price
		CFM	L/min	Bar	Psi	HP	kW	Litres	dB(A)			
CC55904383NCUK	CP4-300-FM TD-UK	29.9	846	11	159	3 + 3	2.2 + 2.2	300	80	230	£1,575.00	£8.36

Champion Compressors

BELT DRIVEN 400V LUBRICATED CHAMPION PRO & ADVANCED SERIES

LOW SPEED,
HIGH OUTPUT

PARTS
ALLIANCE
EXCLUSIVE

2
YEARS

MADE IN
ITALY

200L

FEATURES

- Three Phase, 400 volts
- 3 to 11 kW
- 19.1 to 53.2 CFM
- Star Delta Start (10 & 15HP)
- 2 year standard warranty

CP5-200-FT55
Belt Driven
400v Lubricated
Pro Series
Compressor



At **Champion**, it is our goal to offer complete compressed air solutions that ensure we are a smart and affordable choice for both our customers in small and medium-size industries.

BELT DRIVEN 2-STAGE LUBRICATED - PRO & ADVANCED SERIES

Part No.	Model	Capacity		Pressure		Motor		Receiver	Noise	Volt	Offer Price	5yr Lease
		CFM	L/min	Bar	Psi	HP	kW	Litres	dB(A)			
CC55895270NC	CP4-200-FT4	19.1	541	10	145	4	3	200	74	400	£645.95	£3.43
CC55895346NC	CP5-200-FT55	21.4	606	11	159	5.5	4	200	81	400	£790.95	£4.20
CC55904735NC	CP6-200-FT75	28.2	798	11	159	7.5	5.5	200	81	400	£899.95	£4.78
CC55897466NC	CP10-270-FT10 SDS	44.1	1246	11	159	10	7.5	270	81	400	£1,599.95	£8.49
CC55897821NC	CP15-500-FT155 SDS	53.2	1505	11	159	15	11	500	81	400	£2,350.95	£12.47

BELT DRIVEN SILENCED LUBRICATED CHAMPION PRO SERIES

PARTS
ALLIANCE
EXCLUSIVE

FEATURES

- 230 & 400 volts
- 2.2 to 4 kW
- 11.1 to 23.2 CFM
- 65-68 dB(A)
- Models up to 11kW available
- Dryer versions for 4-11kW
- 2 year standard warranty

NEW



SILENCED BELT DRIVEN LUBRICATED - PRO SERIES

Part No.	Model	Capacity		Pressure		Motor		Receiver	Noise	Volt	Offer Price	5yr Lease
		CFM	L/min	Bar	Psi	HP	kW	Litres	dB(A)			
CC55903823NCUK	CS3-24-FM3-UK	11.1	315	10	145	3	2.2	24	65	230	£1,199.95	£6.37
CC55904623NCUK	CS3-200-CM3-UK	11.1	315	11	159	3	2.2	200	68	230	£1,399.95	£7.43
CC55904671NC	CS4-200-FT4	19.1	541	11	159	4	3	200	68	400	£1,799.95	£9.55
CC55903847NC	CS6-270-FT55	23.2	656	11	159	5.5	4	270	68	400	£1,999.95	£10.62

MADE IN
ITALY

2
YEARS





500L

CALL FOR MORE INFO



500L

BELT DRIVEN LUBRICATED RECEIVER MOUNTED ROTARY SCREW COMPRESSORS



NEW

FEATURES

- Single & three phase models
- 2.2 to 22 kW
- 8, 10 and 13 bar from 7.5-22 kW
- 270 & 500 litre receivers
- Pressure switch control 2.2 to 5.5 kW
- Electronic controller 4 – 22 kW (Premium & FM)
- **5 year extended warranty available (extra cost)**

RECEIVER MOUNTED LUBRICATED + DRYER

Part No.	Model	Capacity		Pressure		Motor		Receiver	Noise	Volt	Offer Price	5yr Lease Price
		CFM	L/min	Bar	Psi	HP	kW	Litres	dB(A)			
CMP1026758B1	KA2/270	8.48	240	10	145	2	2.2	270	61	230	£2,869	£15.23
CMP1026759B1	KA3/270	12.71	360	10	145	4	3	270	61	400	£2,750	£14.60
CMP1026760B1	KA4/270	18.72	530	10	145	5.5	4	270	62	400	£2,795	£14.84
CMP1034065B1	KA4/270 Premium	18.72	530	10	145	5.5	4	270	62	400	£2,995	£15.90
CMP1026761B1	KA5/270	23.66	670	10	145	7.5	5.5	270	66	400	£2,895	£15.37
CMP1034068B1	KA5/270 Premium	23.66	670	10	145	7.5	5.5	270	66	400	£3,150	£16.72
CC1186382	FM 07/270	34.26	970	10	145	10	7.5	500	70	400	£3,895	£20.67
CC1186400	FM 11/270	49.09	1390	10	145	15	11	500	70	400	£4,295	£22.80
CC1186468	FM 15/500	77.69	2200	10	145	20	15	500	73	400	£4,995	£26.51
CC1186472	FM 18/500	95.70	2710	10	145	25	18.5	500	73	400	£5,995	£31.82
CC1186486	FM 22/500	108.06	3060	10	145	30	22	500	74	400	£6,450	£34.23



BELT DRIVEN LUBRICATED RECEIVER MOUNTED ROTARY SCREW COMPRESSORS + REFRIGERATED DRYER

RECEIVER MOUNTED LUBRICATED + REFRIGERATED DRYER

Part No.	Model	Capacity		Pressure		Motor		Receiver	Noise	Volt	Offer Price	5yr Lease Price
		CFM	L/min	Bar	Psi	HP	kW	Litres	dB(A)			
CMP1026762BE2	KA2/CT/270	8.48	240	10	145	3	2.2	270	61	230	£3,495	£18.55
CMP1026763BE2	KA3/CT/270	12.71	360	10	145	4	3	270	61	400	£3,425	£18.18
CMP1026764BE2	KA4/CT/270	18.72	530	10	145	5.5	4	270	62	400	£3,495	£18.55
CMP1034071BE2	KA4/CT/270 Premium	18.72	530	10	145	5.5	4	270	62	400	£3,695	£19.61
CMP1026765BE2	KA5/CT/270	23.66	670	10	145	7.5	5.5	270	66	400	£3,495	£18.55
CMP1034074BE2	KA5/CT/270 Premium	23.66	670	10	145	7.5	5.5	270	66	400	£3,895	£20.67
CC1186424	FM 07/CT/270	34.26	970	11	145	10	7.5	500	70	400	£4,495	£23.86
CC1186432	FM 11/CT/270	49.09	1390	12	145	15	11	500	70	400	£4,975	£26.41
CC1186499	FM 15/CT/500	77.69	2200	13	145	20	15	500	73	400	£4,975	£26.41
CC1186503	FM 18/CT/500	95.70	2710	14	145	25	18.5	500	73	400	£6,895	£36.60
CC1186507	FM 22/CT/500	108.06	3060	15	145	30	22	500	74	400	£6,995	£37.13

FEATURES

- Single & three phase models
- 2.2 to 22 kW
- 8, 10, 13 bar from 7.5 to 22kW
- 270 & 500 litre receivers
- Pressure switch control 2.2 to 5.5 kW
- Electronic controller 4 – 22 kW (Premium & FM)
- Refrigerated Dryer
- Factory Fitted Filtration Pack (option)
- **5 year extended warranty available (extra cost)**

WINNTEC 3 TON AXLE STANDS, RATCHET-TYPE



- 3 Ton maximum weight capacity
- 305 - 450 mm lift height range
- Contact pad for reliable lift support
- Easy ratchet-type jack adjustment
- Integrated foot pads on the base
- Positive lock and handle carrying
- Supplied as a pair of jack stands
- Lightweight - just 3.5kg per jack



ONLY
£39.95

Part No: 09872

WINNTEC 6 TON AXLE STANDS, RATCHET-TYPE



- 6 Ton maximum weight capacity
- 395 - 625mm lift height range
- Contact pad for reliable lift support
- Easy ratchet-type jack adjustment
- Integrated foot pads on the base
- Positive lock and handle carrying
- Supplied as a pair of jack stands
- Lightweight - just 6.4kg per jack



ONLY
£69.95

Part No: 09873

WINNTEC 2 TON LOW-PROFILE TROLLEY JACK

- 2 Ton maximum weight capacity
- 75 - 510mm lifting height range
- Ultra-low profile design for low vehicles
- 'Turbo-Lift' system raises contact saddle to the vehicle surface in one swift motion
- Rubber grip and PU contact saddle pad
- PU wheels reduces noise and damage
- Heat-treated chromed pistons and ram



LOW-PROFILE

PU-WHEELS



ONLY
£149.95

Part No: 987AA0270

with FREE
SIP Winntec High-Density
Foam Kneeling Pad



WINNTEC 3 TON TURBO-LIFT TROLLEY JACK

- 3 Ton maximum weight capacity
- 120 - 450mm lifting height range
- 'Turbo-Lift' system raises contact saddle to the vehicle surface in one swift motion
- PU wheels reduces noise/floor damage
- Safety release valve for safe lowering
- Chrome-plated pistons and main ram
- Heat-treated chromed moving parts
- Durable rubber grip and jack saddle
- Industrial-grade seals and gaskets



PU-WHEELS



ONLY
£149.95

Part No: 987AA0280

with FREE
SIP Winntec High-Density
Foam Kneeling Pad



WINNTEC 2 TON HIGH-LIFT LONG CHASSIS TROLLEY JACK

- 2 Ton maximum weight capacity
- 138 - 800mm lifting height range
- Designed for extreme heavy-duty operation
- Low-profile lifting with a versatile high reach
- Foot-operated pump for very efficient lifting
- Auto overload safety, universal joint valves
- Swivel castors allow for easy movement
- Long ergonomic handle for better usage
- Steel wheels reduce noise and damage
- Integrated jack load control knob



ONLY
£395.95

Part No: 09883

WINNTEC 3 TON TURBO-LIFT HEAVY DUTY TROLLEY JACK

- 3 Ton maximum weight capacity
- 130 - 490mm lifting height range
- 'Turbo-Lift' system raises contact saddle to the vehicle surface in one swift motion
- Dual pump system increases efficiency
- Solid steel wheels for added durability
- Removable two-piece handle and grip
- Chrome-plated main ram and pistons
- Highly durable PU contact pad
- Universal joint release valve



HEAVY-DUTY



ONLY
£195.95

Part No: 09816

WINNTEC SAFERGO WHEEL DOLLY

- 50kg maximum weight capacity
- 680mm dolly width for larger wheels
- 280mm dolly height for added support
- 470mm dolly depth for a reliable base
- Durable carry handle and belt included
- Compact hydraulics for easy movement
- Ideal for emergency road assistance work
- Shock absorbing castors for smoothness
- Frame allows for short working distance
- Comfortable ergonomic design



Part No: 09871
ONLY
£315.95



WINNTEC 24 TON AIR SERVICE JACK

- 24 Ton maximum weight capacity
- Powerful single-stage air service jack
- 141 - 441mm lifting height range
- 3 extensions: 20mm, 50mm, 100mm
- Can both ascend and descend with air
- Long handle for further surface reach
- Dead man controls for added safety
- Hydraulically-assisted components
- Heavy-duty wheels for hard use
- Hard chromed piston/main ram

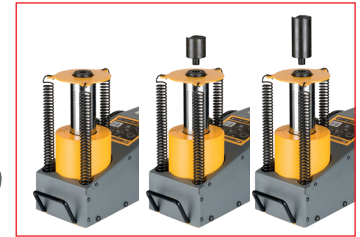
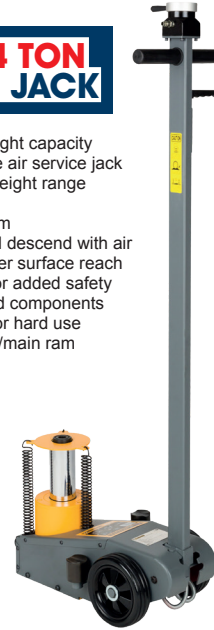

Part No: 09890
ONLY
£725.95

WINNTEC 20 TON HYDRAULIC BOTTLE JACK

- 20 Ton maximum weight capacity
- 244 - 449mm lift height range
- Ideal for horizontal and vertical use
- 60mm screw extension included
- Light and compact construction
- Reliable overload protections
- Solid chromed pump linkage
- Strong wide cast iron base



Part No: 09818
ONLY
£79.95

WINNTEC 10 TON LONG CHASSIS TROLLEY JACK

- 10 Ton maximum weight capacity
- 160 - 680mm lifting height range
- Designed for extreme heavy-duty operation
- Low-profile lifting with a versatile high reach
- Foot-operated pump for very efficient lifting
- Auto overload safety, universal joint valves
- Swivel castors allow for easy movement
- Long ergonomic handle for better usage
- Steel wheels reduce noise and damage
- Integrated jack load control knob



HEAVY-DUTY



Part No: 02886
ONLY
£995.00

WINNTEC 20 TON AIR BOTTLE JACK

- 20 Ton maximum weight capacity
- 245 - 475mm lift height range
- 80mm screw extension included
- Air filters prevent contamination
- Polished ram/chrome pistons
- Strong aluminium air motor
- Heat-treated cylinder wall
- Integrated manual pump
- Heavy-duty welded base



Part No: 09827
ONLY
£215.95

WINNTEC 20 TON LOW-PROFILE AIR BOTTLE JACK

- 20 Ton maximum weight capacity
- 148 - 260mm lift height range
- 45mm screw extension included
- Air filters prevent contamination
- Polished ram/chrome pistons
- Strong aluminium air motor
- Heat-treated cylinder wall
- Heavy-duty welded base



Part No: 09829
ONLY
£215.95



Ravaglioli was founded in 1958; Italian manufacturer and world leader of workshop equipment. Since Ravaglioli started we have utilised our in-house resources to design and manufacture our equipment (mechanics, hardware and software) combining with many years of experience. And so, we keep our products up-to-date with the market changes and needs. We look after our

products with high professionalism, our constant growth testifies this. We are proud to be 100% owners of our technology which is located within our four factories in Italy, where over 40 hardware and software R&D engineers care about their work and research and design, development, mechanics, electronic boards, writing of the necessary software's for all the controls. Possibly the largest manufacturing (company owned) factory in Europe providing a 360-degree production facility that is all totally in house.



KPS306HEK

2-post mechanical lift with a base frame – some Features Capacity 3200 kg

Our equipment is manufactured in **Europe** using high quality engineering at our **Italian factory's**.

ONLY
£2,995

Weekly from: £15.90†

Shaft transmission **requiring no maintenance**, unlike the chain driven base frame lifts that require maintenance to chain & switches with frequent adjustments. Two conic gear-boxes are **adjustment free**. The main nut is **bronze** (not plastic) so offers **high resistance to wear** giving greater safety.

Automatic and permanent nut lubrication of the nut and screw using pots of oil above the nuts, this ensures **lubrication of the nut before** it turns through the screw. **Oil is better** than grease (other manufacturers use) for lubrication of the screw and nuts.

Steel high resistance rolled screw **provides longer life**. The solid base frame (self-supporting) is exceptional as a **solution to poor floors** offering minimum concrete floor thicknesses and poor surface anchorage etc. The columns are constructed in steel being designed to be **sturdy and strong**. Three stage arms provide asymmetric lifting **of off road and large vehicles so to easily open the doors**.

Accessories are available using our K system **quick drop** in adapters or extension pads. Available in 3-phase electrical supply as it's a mechanical lift.

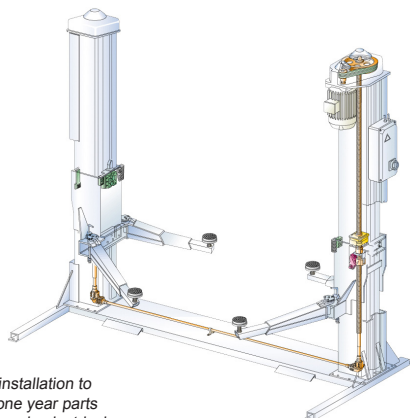

*Price includes delivery to site with access, installation to a prepared site as normal. Also includes a one year parts and labour warranty, excluding any building work, electrical connections, accidental damage or miss use, floods etc.

www.ravaglioli.com

SOLDERING IRON



COMES WITH BATTERY CHARGER & CASE

M12 Soldering Iron

M12

- 1 x M12 SI
- 1 x M12B2
- 1x Pointed Tip
- 1 x C12C
- 1x Flat Tip
- 1 x BMC)
- Supplied in: Kitbox
- Temperature range: 400 °C
- Weight (with battery pack): 0.5 kg
- Battery pack capacity: 2.0 Ah
- Charger supplied: 40 min
- Heat power: 90 W
- No. of batteries supplied: 1



NAKED UNIT ONLY
£129.00

Part No: 987AA1220

WITH BATTERY
£195.00

Part No: 987AA1210

IMPACT RATCHET

0-250 RPM
LOAD SPEED

M12 Fuel Ratchet 1/4"

M12

- Battery pack capacity: n/a
- Charger supplied: n/a
- Max. torque: 54 Nm
- No load speed: 0 - 250 rpm
- No. of batteries supplied: 0
- Weight (with battery pack): n/a
- Battery type: Li-ion
- Length: 291 mm
- Supplied in: n/a
- Voltage: 12 volt



- (M12 1/4" Fuel Impact ratchet, 1/4" to 3/8" Adaptor)

FANTASTIC
IMPACT
RATCHET!

CALL FOR
MORE INFO

NAKED UNIT ONLY
£175.00

Part No: 987AA1230

RATCHET



COMES WITH BATTERY CHARGER & CASE

M12

M12 Fuel Ratchet 3/8"

- M12FIR38
- 1x M12B2,
- 3/8" to 1/4" Adaptor,
- 1x C12C
- 1x Fuel Bag



NAKED UNIT ONLY
£175.00

Part No: 987AA1260

WITH BATTERY
£245.00

Part No: 987AA1240

- Low profile head design allows users better access in tight spaces
- Variable speed metal trigger provides ultimate control of the tool
- Premium rubber overmold withstands corrosive materials and provides increased comfort when in use
- REDLINK PLUS intelligence system delivers advanced digital overload protection for tool and battery and uniquely enhances the tool performance under load
- The LED light illuminates the work area while the on-board fuel gauge displays remaining run time

IMPACT WRENCH

M18 ONE-KEY Fuel Impact Wrench with Friction Ring (1/2" or 3/4") (2 x 5.0Ah batteries, Fast Charger, Dynacase)

- Battery pack capacity: 5.0 Ah
- Battery type: Li-ion
- Charger supplied: 59 min
- Impact rate: 0-950 / 0-1,750 / 0-2,100 / 0-2,100 ipm
- Max. bolt diameter: M33
- Max. fastening torque: 130 / 400 / 1356 / 1356 Nm
- No load speed: 0-550 / 0-1,400 / 0-1,750 / 0-1,750 rpm

- No. of batteries supplied: 2
- Nut-busting torque: 1,898 Nm
- Supplied in: HD Box
- Voltage: 18 volt
- Weight with battery pack: 3.3 kg



ONLY
£569.00

1/2" Part No: 987AA1100
3/4" Part No: 987AA1050



COMES WITH BATTERY CHARGER & CASE

HACKZALL



COMES WITH BATTERY CHARGER & CASE

M18 Fuel Hackzall

- 1 X M18 Fuel Hackzall
- 1 X HD Box
- 1 X blade
- 2 X 5.0Ah batteries
- 1 X M12-18FC)



NAKED UNIT ONLY
£195.00

Part No: 987AA1460

WITH BATTERY ONLY
£345.00

Part No: 987AA1450

- 22 mm stroke length for controlled cutting with a no load stroke rate of 3000 spm
- Pivoting shoe allows the user to optimise his cutting position
- Built in LED light improves visibility in low light cutting applications

ANGLE GRINDER

M18 Fuel Breaking Grinder Paddle Switch

- POWERSTATE Brushless Motor
- REDLINK PLUS intelligent electronics
- Disk brake - stops wheel in under 2 seconds

NAKED UNIT - NO BATTERIES OR CHARGER INCLUDED



CALL FOR
MORE INFO

NAKED UNIT ONLY
£195.00

Part No: 987AA1310

HEATGUN

M18 Heatgun (2 X 5.0Ah batteries, charger, BMC)

- Air volume: 170 l/min
- Battery pack capacity: 5.0 Ah
- Battery type: Li-ion
- Charger supplied: 100 min
- No. of batteries supplied: 2
- Recommended ambient operating temperature: -18 to +52 °C

- Supplied in: Kitbox
- Temperature range: 470 °C
- Voltage: 18 volt
- Weight (with battery pack): 1.4 kg



COMES WITH BATTERY CHARGER & CASE



ONLY
£375.00

HEATGUN

M18 Heatgun (Naked - no batteries or charger)

- Air volume: 170 l/min
- Battery pack capacity: n/a
- Battery type: Li-ion
- Charger supplied: n/a
- No. of batteries supplied: 0
- Recommended ambient operating temperature: -18 to +52 °C

NAKED UNIT - NO BATTERIES OR CHARGER INCLUDED



NAKED UNIT ONLY
£189.00

CALL FOR
MORE INFO

MILWAUKEE WORKSHOP TRILOGY PACK

- M18 ONE-KEY Combi Drill
- M18 ONE-KEY High Torque Impact Wrench 1/2"
- 2x M18 5ah Batteries & Fast Charger
- M18 Fuel Angle Grinder
- Contractor Bag

FREE
M18 ONE-KEY
COMBI DRILL

M18™ ONE-KEY 1/2" High Torque
Impact Wrench & M18 Combi Drill



WITH BAG, CHARGER
& 2x BATTERIES

£549.00

Part No: 987AB0050

HURRY ONLY
WHILE STOCKS LAST!

STUBBY IMPACT WRENCH

M12FIWF38-622X
3/8" Stubby Impact Wrench

- Battery pack capacity: 6.0 Ah + 2.0 Ah
- Battery type: Li-ion
- Performance: 339Nm of torque and 2.700RPM
- 4-Mode Drive Control:
 - Mode 1: 40Nm/ 0-1.200rpm/0-1.100ipm
 - Mode 2: 70Nm/ 0-1.800rpm/0-2.100ipm
 - Mode 3: 339Nm/ 0-2.700rpm/0-3.200ipm
 - Mode 4: 0-2.700rpm and automatically shuts tool down after 1 second of impacting preventing damage

NEW

COMES WITH 2x
BATTERIES & CHARGER



INC. CHARGER
& BATTERIES

£249.00

Part No: 987AB0180

NAKED UNIT ONLY

£159.00

Part No: 987AB0190

M12

STUBBY IMPACT WRENCH

M12FIWF12-622X
1/2" Drive Stubby Impact Wrench

- Battery pack capacity: 6.0 Ah + 2.0 Ah
- Battery type: Li-ion
- Performance: 339Nm of torque and 2.700RPM
- 4-Mode Drive Control:
 - Mode 1: 40Nm/ 0-1.200rpm/0-1.100ipm
 - Mode 2: 70Nm/ 0-1.800rpm/0-2.100ipm
 - Mode 3: 339Nm/ 0-2.700rpm/0-3.200ipm
 - Mode 4: 0-2.700rpm and automatically shuts tool down after 1 second of impacting preventing damage

NEW

COMES WITH 2x
BATTERIES & CHARGER



INC. CHARGER
& BATTERIES

£249.00

Part No: 987AB2000

NAKED UNIT ONLY

£159.00

Part No: 987AB2010

M12

POP RIVET TOOL

M12BPRT-201X
M12 Pop Rivet Tool

- Battery pack capacity: 2.0 Ah
- Battery type: Li-ion
- Performance: 325Nm (4.8mm) Stainless Steel Rivets on a single charge

- Suitability: Will pop all aluminium, steel, stainless steel and copper rivets up to 4.8mm
- Stroke Length: 20.32mm to pop rivets in one stroke

NEW

COMES WITH 1x
BATTERY & CHARGER



INC. CHARGER
& BATTERY

£269.00

Part No: 987AB0150

NAKED UNIT ONLY

£199.00

Part No: 987AB0160

M12

JACKET OR HOODIE? THE CHOICE IS YOURS!!

BATTERY & CHARGER
SOLD SEPERATELY



(OR)

Jacket	GSF Part No.	Description	Size	Price
	987AA7880_Black 987AA7890_Grey	Milwaukee M12 Premium Heated Jacket (Naked-no batteries or charger)	S	£149.00
	987AA9850_Black 987AA7900_Grey	Milwaukee M12 Premium Heated Jacket (Naked-no batteries or charger)	M	£149.00
	987AA9860_Black 987AA7910_Grey	Milwaukee M12 Premium Heated Jacket (Naked-no batteries or charger)	L	£149.00
	987AA9870_Black 987AA7920_Grey	Milwaukee M12 Premium Heated Jacket (Naked-no batteries or charger)	XL	£149.00
	987AA9880_Black 987AA7930_Grey	Milwaukee M12 Premium Heated Jacket (Naked-no batteries or charger)	XXL	£149.00

M12

Hoodie	GSF Part No.	Description	Size	Price
	987AA7940_Grey	Milwaukee M12 Heated Hoodie (Naked-no batteries or charger)	S	£109.05
	987AA7950_Grey	Milwaukee M12 Heated Hoodie (Naked-no batteries or charger)	M	£109.05
	987AA7960_Grey	Milwaukee M12 Heated Hoodie (Naked-no batteries or charger)	L	£109.05
	987AA7970_Grey	Milwaukee M12 Heated Hoodie (Naked-no batteries or charger)	XL	£109.05
	987AA7980_Grey	Milwaukee M12 Heated Hoodie (Naked-no batteries or charger)	XXL	£109.05

Terms & Conditions

- Prices shown are for Trade Customers only.
- Prices exclude VAT, at current rate.
- Prices correct at time of going to press, December 2018.
- Offer ends 31st March 2019.
- Prices subject to change without notice.
- Promotional items subject to availability.

- Errors & Omissions Excluded.
- In all cases please contact local branch for full application/fitment details.
- Images shown are for illustration purposes only, and may or may not reflect the actual products.
- Terms & Conditions available FOC upon request.
- Lease example: Bendix Diagnostics 989AA0650

offer price £1,095 + vat 5 year lease plan - No deposit terms, £25.18 + vat per month. Weekly equivalent £5.81 + vat per week. Subject to status, rental payable by direct debit. Leasing examples quoted are approximate and for illustration purposes only.

- All lease figures are based on a 60 month term lease agreement.
- All lease figures are subject to VAT & status.
- All offers UK mainland only.

- All offers available until 31st March 2019 subject to availability.
- Specifications subject to change without notice.
- Lease figures may vary according to status.
- Non home owners & non established businesses may attract a higher rate.
- All lease transactions are subject to a documentation fee.